

Fan-Powered Terminal Unit Series Flow

Type TFP

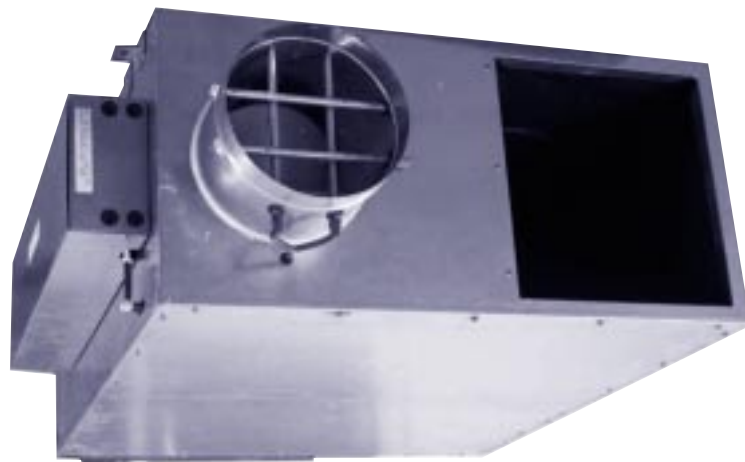

TROX[®] TECHNIK

Trox (Malaysia) Sdn. Bhd.
20 Persiaran Bunga Tanjung 1
Senawang Land Industrial Park
70400 Seremban
Negeri Sembilan Darul Khusus
MALAYSIA

Telephone +60 6 6788188
Telefax +60 6 6788288 / +60 6 6788388
www.troxmal.com.my
e-mail trox@troxmal.com.my

Contents

Contents	2	Fan Performance, Size 5	30
Description	3-7	Acoustical Data, Size 5	
Dimensions Size 2, 4, 5	8	Discharge Sound Power Level · Ext. Press. 50 Pa	31
Dimensions Size 6, 7	9	Discharge Sound Power Level · Ext. Press. 100 Pa	32
Hot Water Coils, Features and Dimensions	10	Radiated Sound Power Level · Ext. Press. 50 Pa	33
Electric Heater, Features and Dimensions	11	Radiated Sound Power Level · Ext. Press. 100 Pa	34
Selection Data	12		
Fan Performance Data, all sizes	13	Fan Performance, Size 6	35
Definitions · Airflow Ranges · Differential Pressure Sensor	14	Acoustical Data, Size 6	
Quick Selection Acoustic, Size 2	15	Discharge Sound Power Level · Ext. Press. 50 Pa	36
Quick Selection Acoustic, Size 4	16	Discharge Sound Power Level · Ext. Press. 100 Pa	37
Quick Selection Acoustic, Size 5	17	Radiated Sound Power Level · Ext. Press. 50 Pa	38
Quick Selection Acoustic, Size 6	18	Radiated Sound Power Level · Ext. Press. 100 Pa	39
Quick Selection Acoustic, Size 7	19		
		Fan Performance, Size 7	40
Fan Performance, Size 2	20	Acoustical Data, Size 7	
Acoustical Data, Size 2		Discharge Sound Power Level · Ext. Press. 50 Pa	41
Discharge Sound Power Level · Ext. Press. 50 Pa	21	Discharge Sound Power Level · Ext. Press. 100 Pa	42
Discharge Sound Power Level · Ext. Press. 100 Pa	22	Radiated Sound Power Level · Ext. Press. 50 Pa	43
Radiated Sound Power Level · Ext. Press. 50 Pa	23	Radiated Sound Power Level · Ext. Press. 100 Pa	44
Radiated Sound Power Level · Ext. Press. 100 Pa	24		
		Hot Water Coil Performance Data	45-48
Fan Performance, Size 4	25	Electric Heater, Features and Selection	49
Acoustical Data, Size 4		Electric Heater Performance Data	49
Discharge Sound Power Level · Ext. Press. 50 Pa	26	Selection Process for TFP Units	50
Discharge Sound Power Level · Ext. Press. 100 Pa	27	Order Details	51
Radiated Sound Power Level · Ext. Press. 50 Pa	28		
Radiated Sound Power Level · Ext. Press. 100 Pa	29		

General

Operation Philosophy

Series flow fan powered terminals offer enhanced space comfort and flexibility in a wide variety of applications. Considerable operating savings can be achieved through the recovery of waste heat, reduced central fan horsepower requirements and night setback operation. TROX Terminal Boxes Type "TFP" take primary and induced air and mix the two thoroughly to provide a constant air supply to the occupied zone of the building. Total flow to the diffuser is kept substantially constant thus giving very good air distribution even with high turn down of the primary air volume.

A pressure independent control of the primary VAV damper is accomplished by use of a differential pressure grid which gives accurate control of air flow even with a 90° bend on the inlet spigot. Mixing between the primary airstream and the induced warm air from the ceiling void is by a forward curved blade centrifugal fan with direct drive motor.

TROX Series Fan Terminal Boxes are eminently suitable for low temperature air applications. If the supply air temperature is low, then the fan volume flow rate must be higher than the primary air volume flow rate to ensure suitable air temperature at the diffuser. The design of the type TFP ensures that at 100 % primary air, sufficient induced air is mixed with the primary air so that the air discharged has a conventional cooling differential which will not cause draught problems in the space being conditioned. The primary air damper can also be fully shut, with 100 % recirculated or induced air.

Indoor Air Quality

The type "TFP" enhances the indoor air quality of a building by providing constant air movement and higher air volumes in the heating mode than typically provided by conventional VAV single duct terminals or parallel flow fan terminals. The higher air flow capacity provides continuous air movement in the space and lowers the heating discharge air temperature. This combination improves air circulation, preventing accumulation of CO₂ concentrations in stagnant areas. Increased air movement improves occupant comfort. The higher air capacity also improves the performance of diffusers.

Acoustic Performance

Another aspect of indoor air quality is also to have a proper selection of air terminal equipment with respect to acoustics. At the zone level, the terminal unit generates acoustical energy that can enter the conditioned space along two primary paths. First, noise from the unit fan can propagate through the downstream duct and diffusers before entering the space (Discharge or Airborne Sound). Acoustic energy is also radiated from the terminal casing and travels through the ceiling void and the false ceiling system before entering the space (Radiated Sound). To properly quantify the amount of acoustic energy emanating from a terminal unit at a specific operating condition (i.e. air flow rate and static pressure), manufacturers must measure and publish sound power levels. TROX type "TFP" Boxes have been designed and developed to achieve low room noise levels. Due to discharge and case radiated noise sound pressure levels of NC 20 can be achieved in the occupied zone. Help in

predicting space sound pressure levels is given in an application standard referred to as ARI Standard 885. This standard provides information to calculate the attenuation of the ductwork, ceiling void, false ceiling system, and conditioned space below a terminal unit. These attenuation values are referred to as the "transfer function" since they are used to transfer from the manufacturer's sound power levels to the estimated sound pressure levels resulting in the space below. Various manufacturers use different assumptions with respect to a "typical" project design. Therefore it is impossible to compare product performance simply by looking at the published NC values. Quick selection tables (page 15 19) use some assumptions of ARI 885 as well as the recommendations of ASHRAE. The acoustic effects of electric heaters or hot water coils can mostly be disregarded and are not included in the acoustic tables of this leaflet.

Sizes

The type "TFP" terminals are available with five fan sizes to handle airflow rates between 150 and 2200 l/s. Most fan sizes are available with three primary air valve sizes to optimize the unit fan and primary air valve combinations required by current industry needs.

TFP, Size 2, 4, 5¹⁾

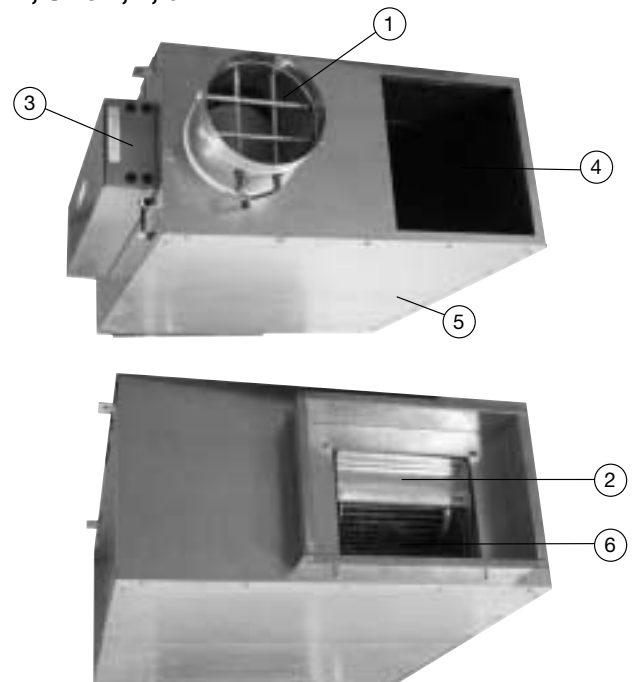

- ① Velocity Flowgrid Primary Air
- ② Fan Motor
- ③ Controls Package
- ④ Air Induction Port
- ⑤ Access Panel
- ⑥ Discharge Port

1) The original product line included also the sizes 1 and 3. These were deleted.

Description

TFP, Size 6, 7

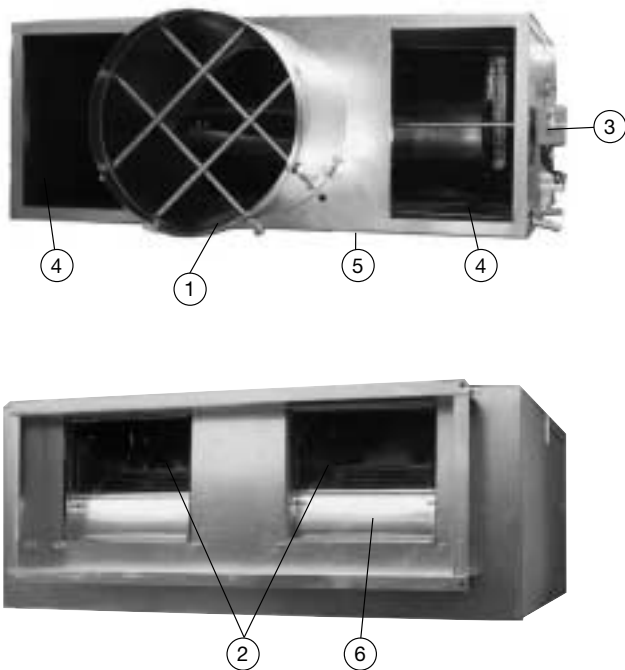

- ① Velocity Flowgrid Primary Air
- ② Fan Motor
- ③ Controls Package
- ④ Air Induction Port
- ⑤ Access Panel
- ⑥ Discharge Port

Quality and Installation

All type TFP terminals are thoroughly inspected during each step of the manufacturing process, including a comprehensive "final factory" inspection, to ensure the highest quality product available. Each unit is also "operationally tested" before leaving the factory to ensure trouble free on site "start-up". A standard single point electrical mains power connection is provided. Electronic controls and electrical components are located on the same side of the casing for quick access, adjustment and trouble-shooting. Installation time is minimized with the availability of factory calibrated TROX controls. The pressure differential sensor grid ensures accurate airflow measurement, regardless of the on site installation conditions. A calibration label and wiring diagram is located on the terminal for quick reference during start-up.

The terminal is constructed to allow installation with standard metal hanging straps.

Construction

Controls

TROX TFP boxes are suitable for pneumatic or electronic control of the primary airflow rate. Here the volume flow rate tolerance is dependent on the type of control system used but is typically $\pm 5\%$ to $\pm 10\%$ of set volume. The units are designed for use in VAV systems and in conjunction with DDC controllers which allow communications between the boxes and a central control area. The primary volume flow control range is typically 100% to 10% depending on type of control. The range is adjustment at the factory with factors supplied to allow site adjustment. The fans volume flow rate tolerance is in accordance to DIN 24166 accuracy class 3. A fan speed adjustment is provided by means of an optional tap transformer. The four tap transformer on the TFP terminal motor provides for a wide range of "on site" flow rate and static pressure combinations.

The Pressure Differential sensor grid provides following features:

- Minimum pressure differential signal from 2 Pa upwards,
- Sensor tubes in aluminium,
- Test pressure tapplings are located in an accessible position and supplied with tight fitting caps,
- Calibration graphs and constants are provided to relate volume flow rate in litres/second to the measured pressure differentials,
- The differential pressure generated by the averaging sensor is within $\pm 3\%$ of the calibration chart value over the range of typical primary air flow rates.

The single blade damper is mounted in the circular duct behind the flow measuring grid. The drive spindle is extended through the casing and a suitable actuator slips over the shaft and locks directly to it. Additional characteristics are:

- The closed damper has a shut off leakage at 500 Pa inlet pressure of less than 0.5% of rated flow,
- The damper blade is positively connected to its drive shaft which runs in maintenance free polyurethane long life bearings,
- EPDM synthetic rubber damper seal, thermoplastic elastomer compound seal suitable for temperatures up to 50 °C.

Differential Pressure Sensor



Casing

The casing is sturdily constructed of galvanised sheet steel. The overall construction is reinforced to meet acoustic performance requirements.

- All 230 V electrical control components are protected by sheet metal enclosures,
- High pressure side with duct spigot suitable for circular ducting,
- Low pressure side suitable for angle frames,
- Mounting brackets for support rods are provided on the top of the casing,
- Casing with internal acoustic and thermal 30 mm faced insulation, erosion resistant up to 20 m/s. The access panels are also lined with the same material.

All lining materials have Class 'O' fire rating conforming to UK building regulations.

To avoid removal of the terminal box once fitted in the system, an access panel is provided in the casing underside so that the fan/motor can be serviced, or in the unlikely event of failure, removed without disturbing the duct connections.

Electric Heaters

The electric heater is available as an integral unit complete with controls including fuses and interlocks. The integral air heater has elements designed for black heat operation and consists of nickel chrome heating elements. An automatic reset high temperature cut out is fitted and an earth stud included. The heater is manufactured to British Standards/ Codes as applicable and fully factory tested. An optional low air pressure switch can be fitted. This switch will disconnect the heater if the fan stops. The heater elements are wired back into the control enclosure, including the earth, and heater fuses can be supplied. Control of the heater can be arranged as three stage step control or as stepless control with thyristors. Control type should be selected to suit the temperature controller used and the degree of accuracy required on temperature control.

Hot Water Heating Coils

The hot water heating coil is available as an integral unit complete with controls and control valves. The significant features are as follows:

- Galvanized steel casing with flanges on both ends,
- Aluminium corrugated fins, fin spacing is 2.5 mm,
- Copper-tubes with DN15, flow and return connections are standardized,
- Max. working pressure is 16 bar,
- Tubes are transverse jointed.

Description

Fan Units



Fan and Motor

The Series Fan terminal boxes are fitted with fan casings (Scrolls) manufactured from sheet steel. The fans have a forward curved fan impellers. All fan motors are direct drive resiliently mounted via location brackets and suitable for 220-230 volts 50 Hz single phase supply. They are supplied with auto reset thermal overloads. The fan motors are three tap, three winding, permanent split capacitor types fitted with permanently lubricated bearings. Three tap motors provide superior energy efficiency over single speed motors by delivering three separate power outputs. All earthing wiring and component selection conforms to local wiring requirements. All fan motors fitted to TROX Series TFP Boxes are suitable for fan speed control. Optionally supplied is a manually adjusted four tap transformer, which provides in combination with the three motor windings a wide range of operational speeds. The system is matched to the motor and includes minimum voltage limits to ensure stable motor operation.

Accessories

Provision is made on the induction port of the unit for the installation of air filters. These are supplied as throwaway filters.

Design Recommendations and Selection Guidelines

Central Fan Unit Noise levels in the conditioned space are frequently influenced by central fan discharge noise that either breaks out (radiates) from the ductwork or propagates through the distribution ductwork and enters the space as airborne (discharge) noise. Achieving acceptable noise levels in the conditioned space begins with a properly designed central fan system which delivers relatively quiet air to each zone.

Supply Duct Pressure

One primary factor contributing to noisy systems is high static pressure in the primary air duct. This condition causes higher noise levels from the central fan and also higher noise levels from the terminal unit as the primary air valve closes to reduce the pressure. This situation is compounded when a flexible duct is used at the terminal inlet, this allows the central fan noise and air valve noise to break out into the ceiling void and then enter the conditioned space below the terminal. Ideally, the system static pressure should be reduced to the point where the terminal unit installed on the duct run associated with the highest pressure drop has the minimum required inlet pressure to deliver the design primary airflow to the zone. A more cautious approach is to utilize a pressure reducing device upstream of the terminal unit on those few zones closest to the central fan. This device could simply be a manual damper if located well upstream of the terminal inlet. This approach allows all of the terminal units to experience a similar (lower) inlet pressure. They can be selected in a consistent manner at lower inlet pressure conditions that will allow more optimised size of unit. An inlet duct that is the same size as the terminal inlet spigot and as straight as possible will achieve the best acoustic performance. For critical applications, flexible duct should not be used at the terminal inlet.

Zoning

On projects where internal lining of the downstream ducting is not permitted, special attention to design is required to ensure that acceptable noise levels will be obtained. In these cases, a greater number of smaller zones will help in reducing the noise levels. Where possible, the first diffuser takeoff should be located after an elbow or tee and a greater number of small sized diffusers should be used, rather than a few large sized diffusers. The downstream ductwork should be carefully designed and installed to avoid noise regeneration. Locate diffusers downstream of the terminal in areas where the airflow has completely developed i.e free from turbulence. Downstream balancing dampers can cause noise problems if placed too close to the terminal, or when excessive air velocities exist. If tee arrangements are employed, volume control dampers should be used in each branch of the tee, and balancing dampers should be provided at each diffuser spigot. This arrangement provides maximum flexibility in quiet balancing of the system. Casing radiated noise usually dictates the overall room sound levels directly below the terminal. Because of this, special consideration should be given to the location of these terminals as well as to the size of the zone. Larger zones should have the terminal located over a corridor or open plan office space and not over a small confined private office. Fan powered terminals should never be installed over small occupied spaces where the wall partitions extend from slab-to slab (i.e. fire walls or privacy walls).

Selection

The type TFP fan terminal has been designed to provide maximum flexibility in matching primary air valve capacities (cooling loads) with unit fan capacities. The overall unit size is dictated by the fan size. With each unit fan size, a number of primary air valve sizes are available to handle a wide range of cooling capacities. First select the size of the fan, this will determine the overall unit size. The preselection is made by cross plotting the specified fan capacity and external static pressure on the appropriate fan performance curves (see page 13). When terminals have hot water heating coils the coil pressure drop must be added to the design external static pressure (ESP) to obtain a total value for selection purposes. It is common to have more than one fan size which can meet the design requirements. Typically, the selection begins with the smallest fan that can meet the capacity. Occasionally this selection may not meet the acoustic requirements and thus the next larger fan size should be selected. "Upsizing" may also occur when it is necessary to meet the design capacity on the medium or low motor tap. Fan selections can be made anywhere on the characteristic curves. Each fan performance curve depicts the actual performance of the relative motor tap without additional fan balance adjustment. Actual specified capacities which fall below a particular fan curve (low, medium or high) is obtained by using a tap transformer. After the actual fan is selected, the unit size is fixed. Then the appropriate primary air valve is selected. Most of the unit fan sizes have three air valve sizes to select from. The middle size will typically be used. It is the size that is matched with the unit fan to deliver 100 % cooling capacity for the majority of fan selections. A larger primary air valve will be used in applications where the system fan is under-sized, requiring a larger air valve to take advantage of lower pressure losses. In this case a penalty is paid by having a higher controllable minimum airflow setpoint than could be achieved with a smaller inlet size. The smaller primary air valve will most often be used with thermal storage systems where lower than normal primary air temperatures are utilized. In these cases, the maximum design primary airflow is less than the fan capacity (typically 60 to 80 %), and therefore a smaller air valve may be appropriate.

Dimensions Size 2, 4, 5

Unit Size	Spigot Size	$\varnothing D_a$	L	W	H	C	E	F	G	R	S	K	M	N	P
2	5	124	885	762	386	150	320	275	84	30	100	290	330	340	295
	6	149	885	762	386	150	320	275	84	30	115	290	330	340	295
	8	199	885	762	386	150	320	275	84	30	145	290	330	340	295
4	8	199	1050	912	446	175	460	325	84	60	115	360	390	480	345
	10	249	1050	912	446	175	460	325	84	60	175	360	390	480	345
	12	299	1050	912	446	175	460	325	84	60	235	360	390	480	345
5	10	249	1185	1142	446	175	680	325	130	60	175	546	390	710	355
	12	299	1185	1142	446	200	680	325	130	60	305	546	390	710	355
	14	349	1185	1142	446	310	680	325	130	60	200	546	390	710	355

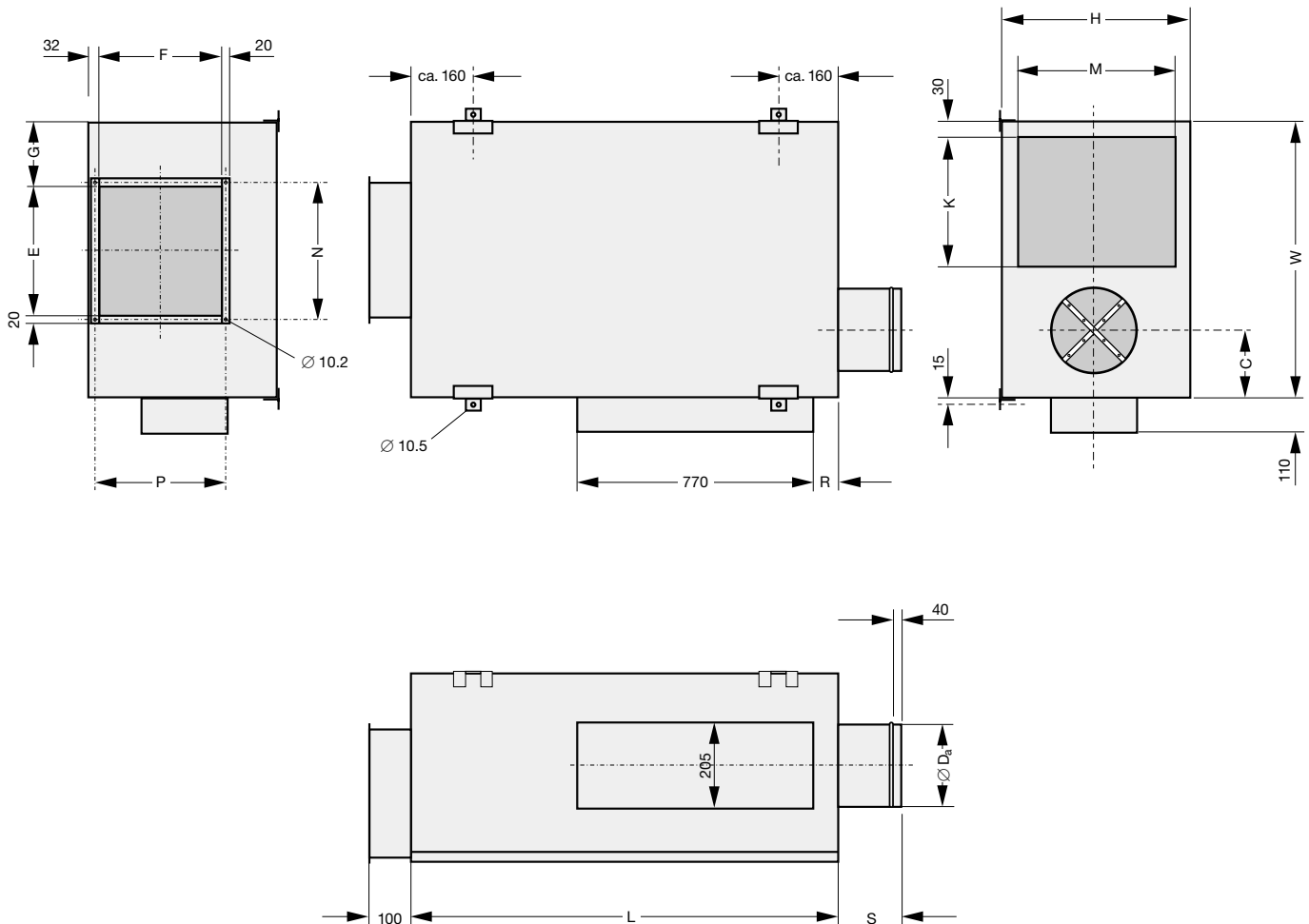

Dimensions Size 6, 7

Unit Size	Spigot Size	$\varnothing D_a$	L	W	H	E	F	G	S	K	M
6	12	299	1047	1143	446	920	325	200	237	250	390
	14	349	1047	1143	446	920	325	200	306	250	390
	16	399	1047	1143	446	920	325	200	365	250	390
7	12	299	1182	1300	446	1200	375	250	237	360	390
	14	349	1182	1300	446	1200	375	250	306	360	390
	16	399	1182	1300	446	1200	375	250	365	360	390

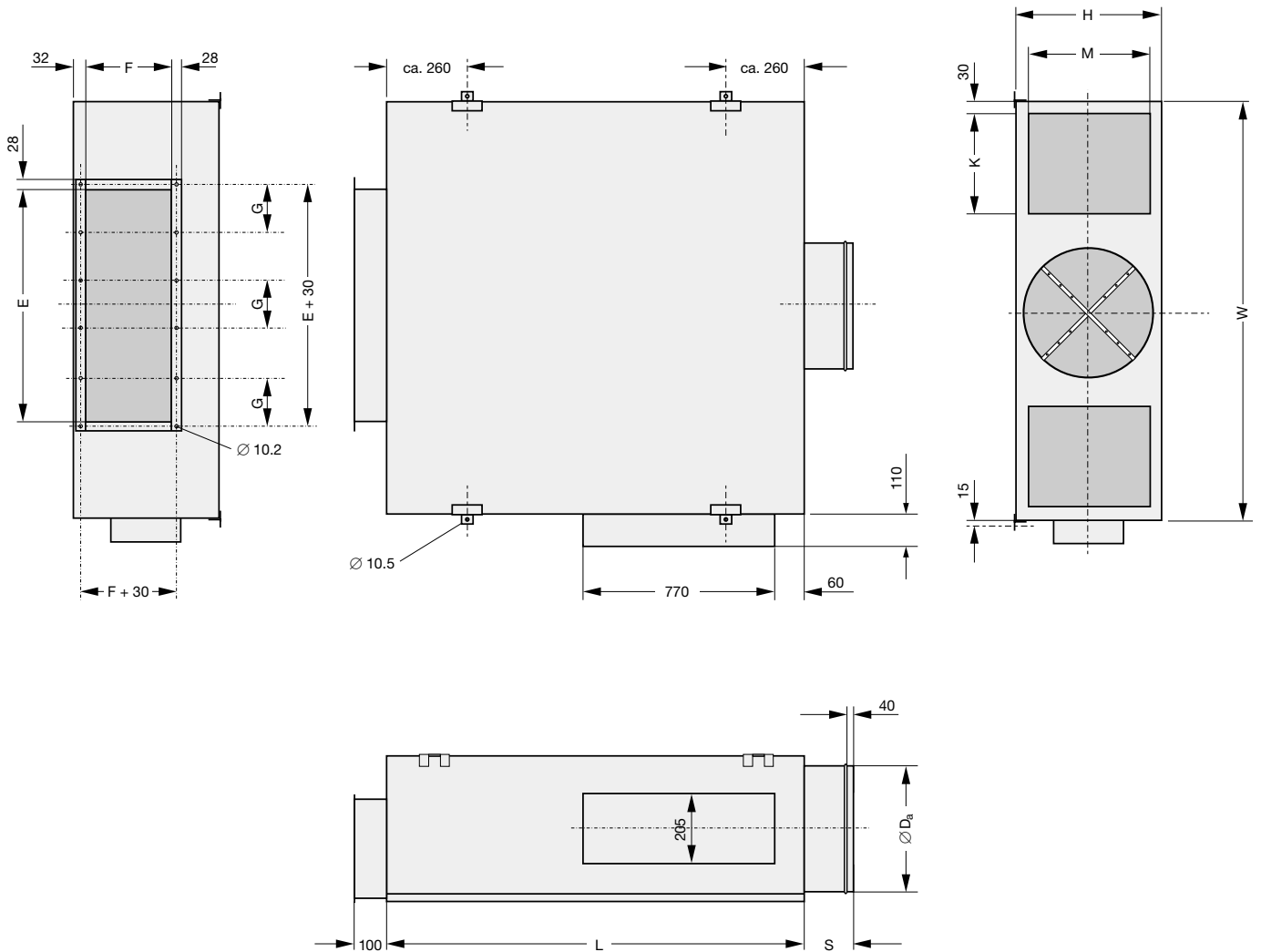

Hot Water Coils, Features and Dimensions

Unit Size	Row	P	J	R	T	E	F	G	Q	U	V
2	1	80	510	30	228	320	275	-	20	340	295
	2	120	670	60	257						
4	1	80	650	30	266	460	325	-	20	480	345
	2	120	810	60	307						
5	1	80	870	30	266	680	325	-	20	700	345
	2	120	1030	60	307						
6	1	80	1110	30	266	920	325	200	28	950	355
	2	120	1270	60	307						
7	1	80	1390	30	342	1200	375	250	28	1230	405
	2	120	1550	60	356						

Connection hot Water Coil

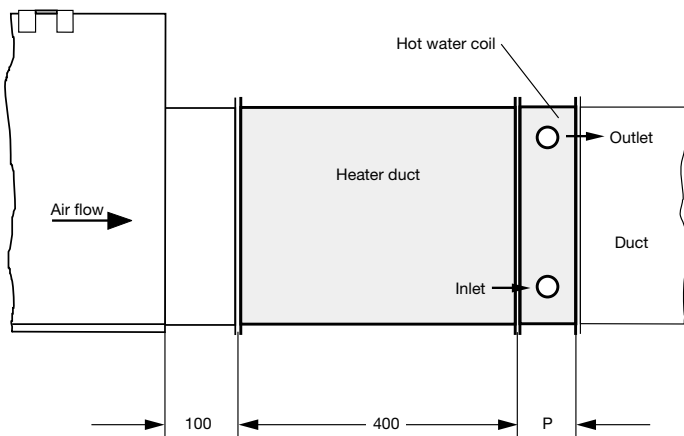

1 Row Size 2 ... 7

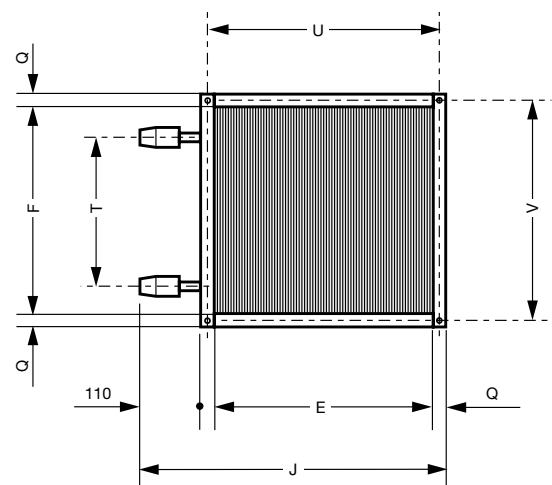

2 Row Size 2, 4, 5

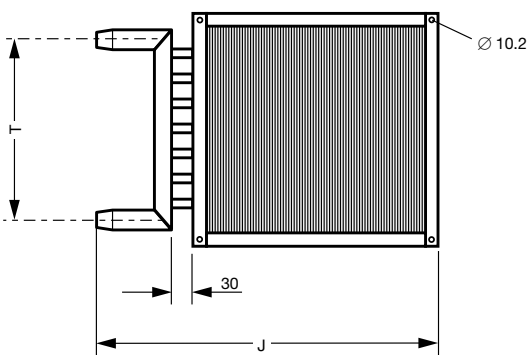

2 Row Size 6 and 7

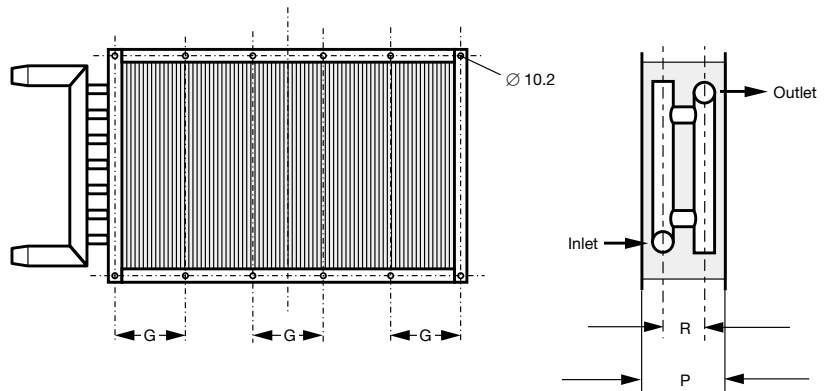

Electric Heater, Features and Dimensions

Unit Size	V	E	F	Q
2	360	320	275	20
4	500	460	325	20
5	720	680	325	20
6	960	920	325	28
7	1240	1200	375	28

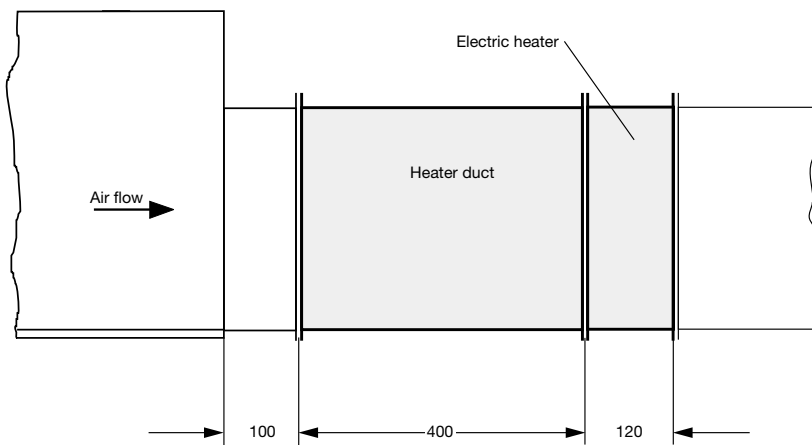

Size 2, 4, 5

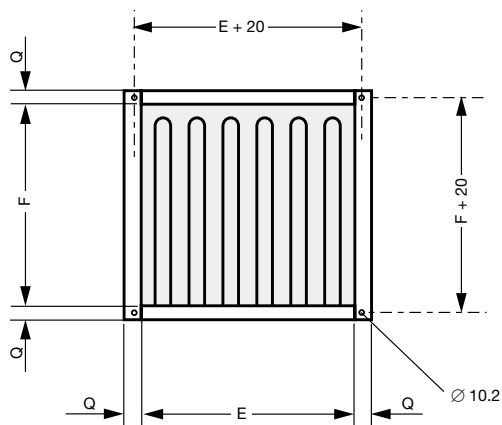

Size 6 and 7

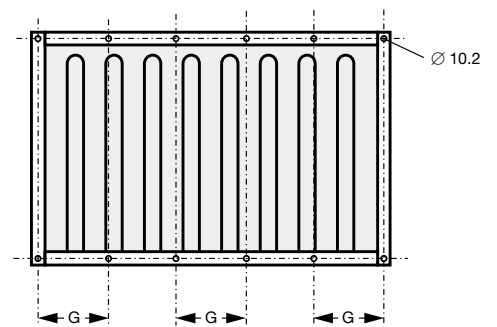

Selection Data

Air Flow Ranges and Fan Electrical Data

TFP Unit Size		Fanmotor tap						Fan power	max. electrical power input	max. Motor Amperage 230/220 V 50 Hz			
		low	med.	high	low	med.	high						
		Flow rates											
		l/s			CFM								
							W	W	Ampere				
2	$\dot{V}_{fan\ min}$	150	200	250	318	424	529	147	418	1.9			
	$\dot{V}_{fan\ max}$	230	310	440	487	656	932						
2-05	$\dot{V}_{pri\ min}$	15			32								
	$\dot{V}_{pri\ max}$	170			360								
2-06	$\dot{V}_{pri\ min}$	25			53								
	$\dot{V}_{pri\ max}$	240			508								
2-08	$\dot{V}_{pri\ min}$	40			85								
	$\dot{V}_{pri\ max}$	435			921								
4	$\dot{V}_{fan\ min}$	300	400	500	635	847	1059				245	550	2.5
	$\dot{V}_{fan\ max}$	480	650	750	1016	1376	1588						
4-08	$\dot{V}_{pri\ min}$	40			85								
	$\dot{V}_{pri\ max}$	435			921								
4-10	$\dot{V}_{pri\ min}$	60			127								
	$\dot{V}_{pri\ max}$	690			1461								
4-12	$\dot{V}_{pri\ min}$	90			191								
	$\dot{V}_{pri\ max}$	1000			2118								
5	$\dot{V}_{fan\ min}$	450	550	650	953	1165	1376	550	1144	5.2			
	$\dot{V}_{fan\ max}$	680	850	1100	1440	1800	2329						
5-10	$\dot{V}_{pri\ min}$	60			127								
	$\dot{V}_{pri\ max}$	690			1461								
5-12	$\dot{V}_{pri\ min}$	90			191								
	$\dot{V}_{pri\ max}$	1000			2118								
5-14	$\dot{V}_{pri\ min}$	130			275								
	$\dot{V}_{pri\ max}$	1375			2912								
6	$\dot{V}_{fan\ min}$	600	800	1000	1271	1694	2118				490	1100	5.0
	$\dot{V}_{fan\ max}$	920	1280	1500	1948	2711	3176						
6-12	$\dot{V}_{pri\ min}$	90			191								
	$\dot{V}_{pri\ max}$	1000			2118								
6-14	$\dot{V}_{pri\ min}$	130			275								
	$\dot{V}_{pri\ max}$	1375			2912								
6-16	$\dot{V}_{pri\ min}$	170			360								
	$\dot{V}_{pri\ max}$	1800			3812								
7	$\dot{V}_{fan\ min}$	900	1100	1300	1906	2329	2753	1100	2288	10.4			
	$\dot{V}_{fan\ max}$	1300	1750	2100	2753	3706	4447						
7-12	$\dot{V}_{pri\ min}$	90			191								
	$\dot{V}_{pri\ max}$	1000			2118								
7-14	$\dot{V}_{pri\ min}$	130			275								
	$\dot{V}_{pri\ max}$	1375			2912								
7-16	$\dot{V}_{pri\ min}$	170			360								
	$\dot{V}_{pri\ max}$	1800			3812								

N.B. The max. primary flow rate $\dot{V}_{pri\ max}$ should never exceed the max. fan flow rate $\dot{V}_{fan\ max}$ as adjusted.

Fan Performance Data

Size 2

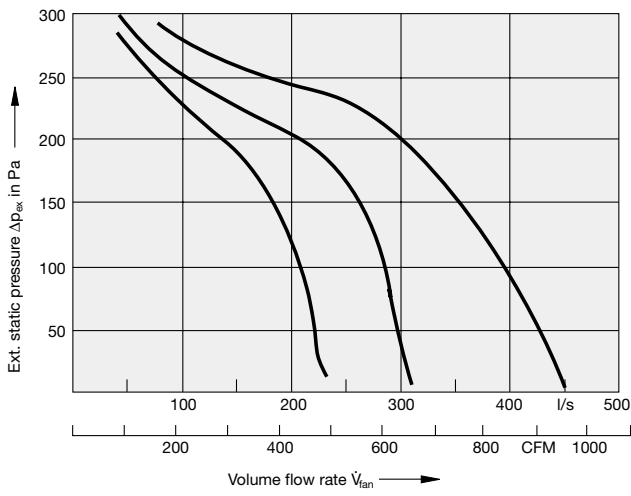

Size 6

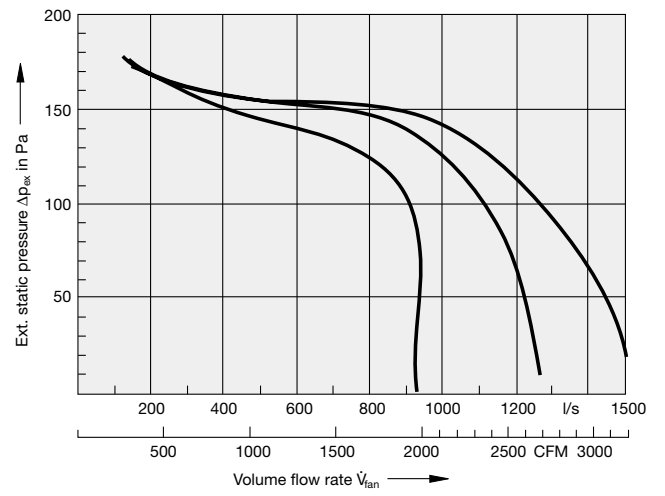

Size 4

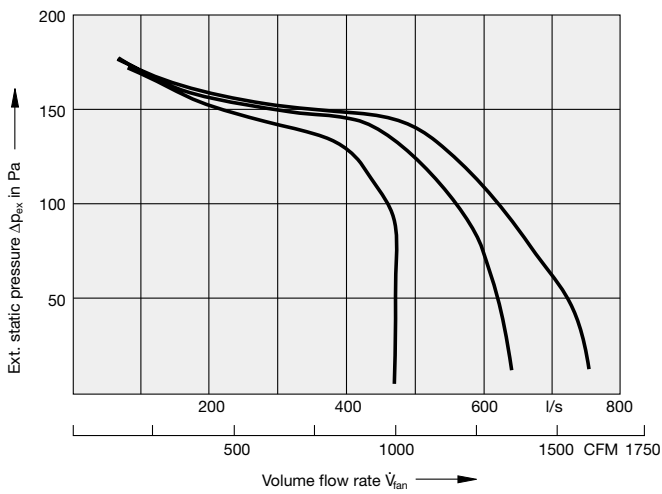

Size 7

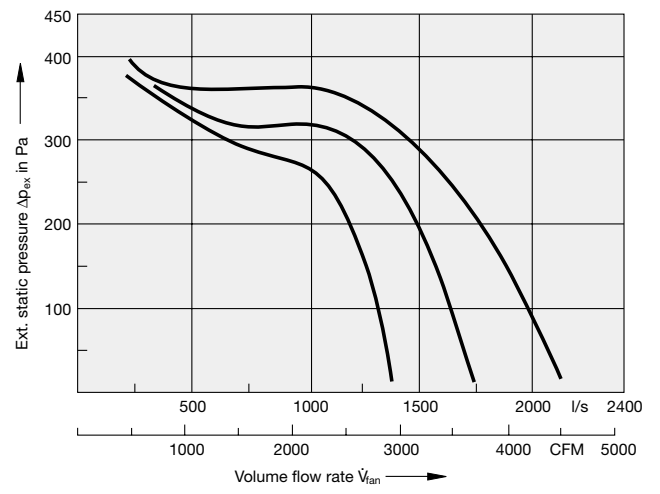

Size 5

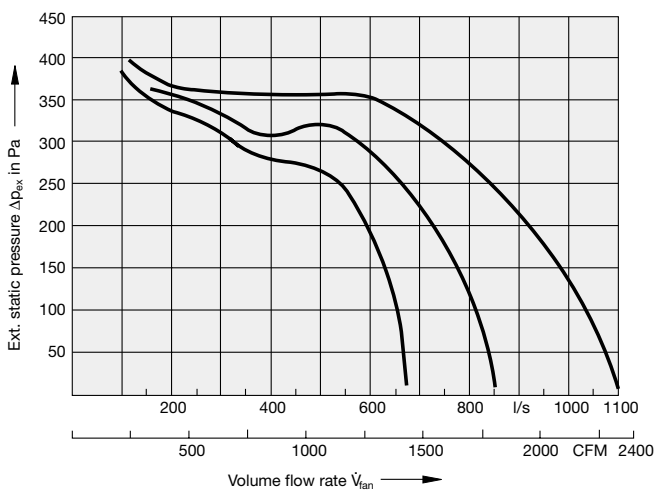

Definitions · Airflow Ranges · Differential Pressure Sensor

Definitions

Δp_{ex} in Pa: External duct static pressure loss (no hot water coils or electric heater considered)

Δp_{in} in Pa: Inlet static pressure loss

V_{pri} in CFM or l/s: Primary air flow rate

V_{fan} in CFM or l/s: Fan air volume flow rate

\dot{V} in CFM or l/s: Volume flow rate

L_w : Air generated sound power level measured in reverberation chamber (re 1pW)

L_{w1} : Case generated sound power level measured in reverberation chamber (re 1pW)

f_m in Hz: Octave band center frequency

V_w in l/h: Water flow

v_w in m/s: Water velocity

v_a in m/s: Air velocity

ΔP_w in kPa: Water flow resistance

ΔP_a in Pa: Air flow resistance of hot water coils or electric heater

\dot{Q}_w in kW: Heat output (hot water heating coil)

\dot{Q}_E in kW: Heat output (electric heating coil)

$\dot{Q}_{E\ max}$ in kW: Max. allowable heat output (electric heating coil)

Differential Pressure Sensor

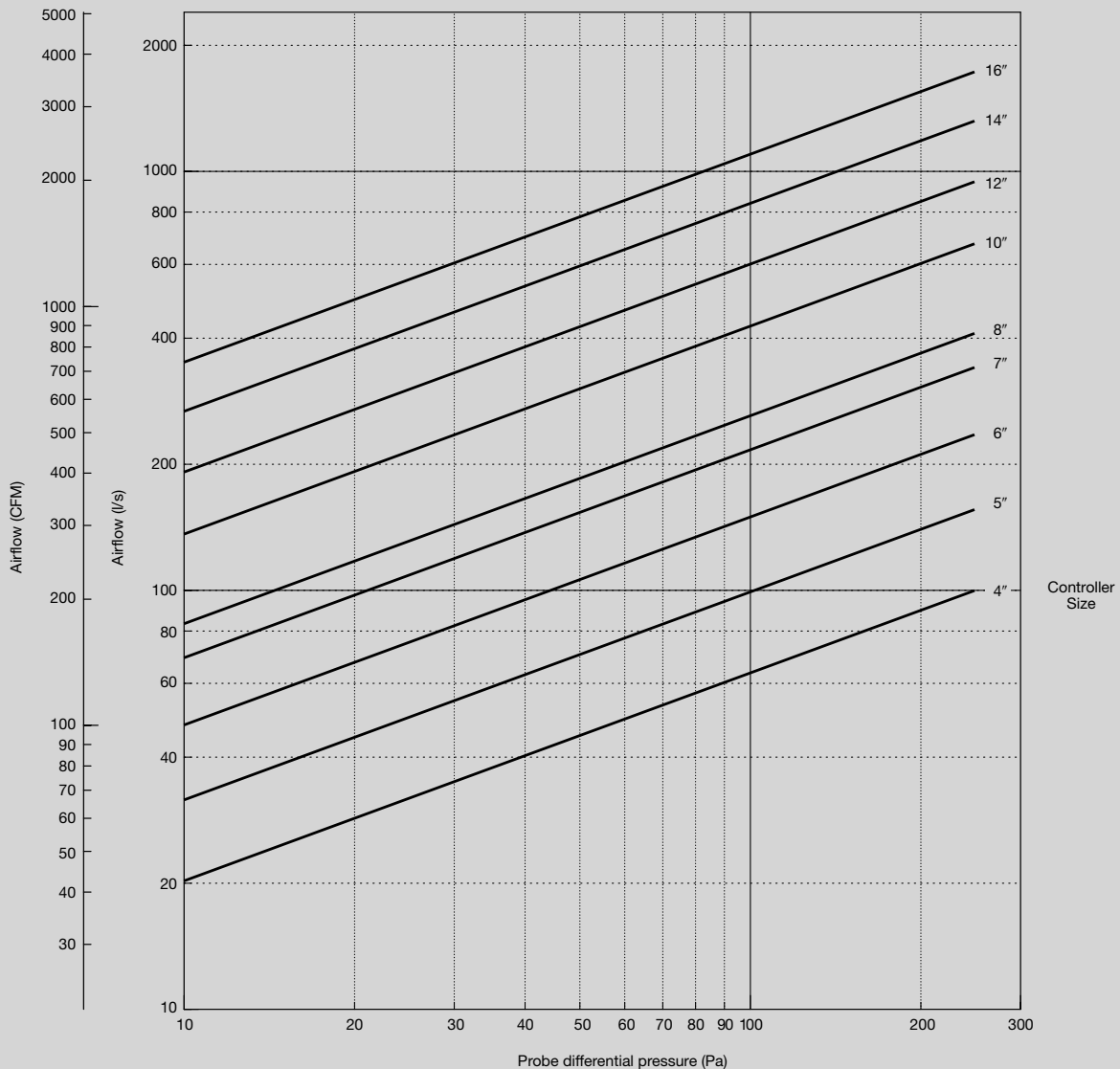

Quick Selection Acoustic, Size 2

Estimated (occupied) Space NC Sound Levels

(procedure see ARI Standard 558-1998 + Addendum 2002)

Unit Size	Fan Flow-Rate		Flow division: Number of outlets	External static pressure Δp_{ex}											
				50 Pa						100 Pa					
	l/s CFM			Discharge noise			Radiated noise			Discharge noise			Radiated noise		
				Inlet static pressure Δp_{in}											
		100	200	500	100	200	500	100	200	500	100	200	500		
2-05	150	318	2	<	<	<	<	<	<	<	<	<	<	<	<
	200	424	2	<	<	<	<	<	<	<	<	<	<	<	<
2-06	150	318	2	<	<	<	<	<	<	<	<	<	<	<	<
	200	424	2	<	<	<	<	<	<	<	<	<	<	<	<
	250	530	2	<	<	<	<	<	<	<	<	15	<	<	15
	300	636	3	<	<	16	15	16	19	<	15	16	18	19	21
	350	742	3	16	17	18	20	21	24	17	17	18	22	22	24
400	848	3	19	19	20	24	25	26	18	19	19	24	25	26	
2-08	150	318	2	<	<	<	<	<	<	<	<	<	<	<	<
	200	424	2	<	<	<	<	<	<	<	<	<	<	<	<
	250	530	2	<	<	<	<	<	15	<	<	<	<	<	15
	300	636	3	<	<	15	15	16	19	15	15	16	15	17	19
	350	742	3	16	17	18	18	19	22	17	18	18	19	20	22
400	848	3	18	19	20	20	21	24	19	19	20	22	22	24	

70 % primary air
< denotes < NC 15

Trox Acoustic Discharge Noise Performance Notes:

(one outlet in calculated space)

- Environmental adjustment factor
- Flow division (max. flow per outlet 300 CFM)
- Insertion loss of lined rectangular duct 12" x 12" (305 x 305 mm)
Ductlength 5 ft. (1.52 m)
- Insertion loss of lined circular flexible duct 8"
Ductlength 6 ft. (1.83 m)
Endreflection (Outlet 12" x 12") (305 x 305 mm)
- Space effect
Distance 10 ft. (3.05 m)
Roomvolume 5000 ft³. (141.6 m³)

Trox Acoustic Radiated Noise Performance Notes:

(one box in calculated space)

- Environmental adjustment factor
- Ceiling/Space Effect
3 ft. deep ceiling cavity
5/8" thick 20 lb./ft³. mineral fiber ceiling tile
- Space effect
Distance 10 ft. (3.05 m)
Roomvolume 5000 ft³. (141.6 m³)

Quick Selection Acoustic, Size 4

Estimated (occupied) Space NC Sound Levels

(procedure see ARI Standard 558-1998 + Addendum 2002)

Unit Size	Fan Flow-Rate l/s CFM		Flow division: Number of outlets	External static pressure Δp_{ex}											
				50 Pa						100 Pa					
				Discharge noise			Radiated noise			Discharge noise			Radiated noise		
				Inlet static pressure Δp_{in}											
			100	200	500	100	200	500	100	200	500	100	200	500	
4-08	300	636	3	<	<	<	<	<	<	<	<	<	<	<	17
	350	742	3	<	<	<	<	<	15	<	<	<	<	15	17
	400	848	3	<	<	<	<	<	19	<	<	<	16	16	17
	450	954	4	<	<	<	16	17	19	<	<	<	16	17	18
	500	1060	4	<	<	15	19	20	20	<	<	<	17	17	19
	550	1166	4	<	<	17	19	19	22	-	-	-	-	-	-
4-10	300	636	3	<	<	<	<	<	<	<	<	<	<	<	<
	350	742	3	<	<	<	<	<	15	<	<	<	<	<	15
	400	848	3	<	<	<	<	15	17	<	<	<	15	15	17
	450	954	4	<	<	<	15	16	18	<	<	<	16	17	18
	500	1060	4	<	<	<	17	17	19	<	<	<	17	17	19
	550	1166	4	<	<	15	18	18	21	<	<	15	18	18	21
	600	1271	5	<	<	15	20	19	22	<	<	16	20	19	22
	650	1377	5	16	17	17	21	22	23	<	15	16	20	21	23
700	1483	5	17	16	17	22	22	25	-	-	-	-	-	-	
4-12	300	636	3	<	<	<	<	<	<	<	<	<	<	<	<
	350	742	3	<	<	<	<	<	<	<	<	<	<	<	<
	400	848	3	<	<	<	<	<	16	<	<	<	<	<	17
	450	954	4	<	<	<	<	15	17	<	<	<	17	17	19
	500	1060	4	<	<	15	17	18	20	<	<	15	18	18	20
	550	1166	4	<	15	16	19	20	21	<	15	16	19	19	22
	600	1271	5	<	15	17	20	20	23	<	15	18	21	21	24
	650	1377	5	15	15	18	22	23	25	15	16	18	21	23	25
700	1483	5	16	17	19	23	24	26	-	-	-	-	-	-	

70 % primary air
< denotes < NC 15

Trox Acoustic Discharge Noise Performance Notes:

(one outlet in calculated space)

- Environmental adjustment factor
- Flow division (max. flow per outlet 300 CFM)
- Insertion loss of lined rectangular duct 12" x 12" (305 x 305 mm)
Ductlength 5 ft. (1.52 m)
- Insertion loss of lined circular flexible duct 8"
Ductlength 6 ft. (1.83 m)
Endreflection (Outlet 12" x 12") (305 x 305 mm)
- Space effect
Distance 10 ft. (3.05 m)
Roomvolume 5000 ft³. (141.6 m³)

Trox Acoustic Radiated Noise Performance Notes:

(one box in calculated space)

- Environmental adjustment factor
- Ceiling/Space Effect
3 ft. deep ceiling cavity
5/8" thick 20 lb./ft³. mineral fiber ceiling tile
- Space effect
Distance 10 ft. (3.05 m)
Roomvolume 5000 ft³. (141.6 m³)

Quick Selection Acoustic, Size 5

Estimated (occupied) Space NC Sound Levels

(procedure see ARI Standard 558-1998 + Addendum 2002)

Unit Size	Fan		Flow division: Number of outlets	External static pressure Δp_{ex}											
				50 Pa						100 Pa					
	Flow-Rate			Discharge noise			Radiated noise			Discharge noise			Radiated noise		
	l/s	CFM		Inlet static pressure Δp_{in}											
			100	200	500	100	200	500	100	200	500	100	200	500	
5-10	450	954	4	<	<	<	15	15	16	–	–	–	–	–	–
	500	1060	4	<	<	15	17	17	19	15	15	16	17	18	20
	550	1166	4	17	17	18	19	20	22	17	17	18	20	21	22
	600	1271	5	18	18	18	21	22	23	18	18	19	21	22	23
	650	1377	5	19	19	20	22	23	25	18	18	19	21	23	25
	700	1483	5	21	21	22	23	24	26	21	21	21	25	25	27
	750	1589	6	21	21	22	24	26	28	21	21	22	26	27	29
	800	1695	6	22	22	23	25	27	29	–	–	–	–	–	–
	850	1801	7	23	23	24	25	30	30	–	–	–	–	–	–
900	1907	7	24	24	25	28	29	31	–	–	–	–	–	–	
5-12	450	954	4	<	<	<	<	15	17	–	–	–	–	–	–
	500	1060	4	<	<	<	16	17	18	15	15	15	17	17	19
	550	1166	4	17	17	17	18	18	20	17	17	17	18	19	20
	600	1271	5	18	18	18	20	20	22	18	18	18	20	21	22
	650	1377	5	19	19	20	21	22	23	18	18	19	20	21	23
	700	1483	5	21	21	21	22	23	25	21	22	22	24	25	26
	750	1589	6	21	21	22	23	24	27	21	21	22	25	26	27
	800	1695	6	22	22	23	24	26	28	22	22	23	26	27	28
	850	1801	7	23	23	24	26	27	29	23	23	23	27	28	29
	900	1907	7	24	24	25	27	28	30	23	23	24	28	29	30
	950	2013	7	25	25	25	28	29	31	24	25	25	29	29	31
1000	2119	8	25	25	26	29	30	33	24	25	25	30	31	32	
1050	2166	8	26	26	27	31	32	34	25	25	26	30	32	33	
5-14	450	954	4	<	<	<	<	16	19	–	–	–	–	–	–
	500	1060	4	15	16	16	18	19	21	16	17	17	18	19	21
	550	1166	4	18	18	19	20	21	23	19	19	19	21	22	24
	600	1271	5	19	20	20	22	23	26	20	20	21	24	24	26
	650	1377	5	21	21	22	24	25	28	20	20	21	22	24	26
	700	1483	5	23	23	23	25	26	29	24	25	25	27	28	30
	750	1589	6	23	23	24	26	28	30	24	24	25	28	29	31
	800	1695	6	25	25	25	27	29	31	25	25	26	29	30	32
	850	1801	7	26	26	27	30	31	33	26	26	26	30	31	33
	900	1907	7	27	27	28	32	32	34	27	27	27	31	33	34
	950	2013	7	28	28	28	31	34	35	27	27	28	32	33	35
	1000	2119	8	28	28	29	33	34	36	28	28	29	33	34	36
1050	2166	8	29	30	30	34	35	37	–	–	–	–	–	–	

70 % primary air
< denotes < NC 15

Trox Acoustic Discharge Noise Performance Notes:

(one outlet in calculated space)

- Environmental adjustment factor
- Flow division (max. flow per outlet 300 CFM)
- Insertion loss of lined rectangular duct 12" x 12" (305 x 305 mm)
Ductlength 5 ft. (1.52 m)
- Insertion loss of lined circular flexible duct 8"
Ductlength 6 ft. (1.83 m)
Endreflection (Outlet 12" x 12") (305 x 305 mm)
- Space effect
Distance 10 ft. (3.05 m)
Roomvolume 5000 ft³. (141.6 m³)

Trox Acoustic Radiated Noise Performance Notes:

(one box in calculated space)

- Environmental adjustment factor
- Ceiling/Space Effect
3 ft. deep ceiling cavity
5/8" thick 20 lb./ft³. mineral fiber ceiling tile
- Space effect
Distance 10 ft. (3.05 m)
Roomvolume 5000 ft³. (141.6 m³)

Quick Selection Acoustic, Size 6

Estimated (occupied) Space NC Sound Levels

(procedure see ARI Standard 558-1998 + Addendum 2002)

Unit Size	Fan Flow-Rate l/s CFM		Flow division: Number of outlets	External static pressure Δp_{ex}											
				50 Pa						100 Pa					
				Discharge noise			Radiated noise			Discharge noise			Radiated noise		
				Inlet static pressure Δp_{in}											
			100	200	500	100	200	500	100	200	500	100	200	500	
6-12	500	1060	4	-	-	-	-	-	-	<	<	<	15	16	21
	600	1271	5	<	<	<	<	<	20	<	<	<	16	17	22
	700	1483	5	<	<	<	16	17	22	<	<	<	18	19	23
	800	1695	6	<	<	<	19	21	24	<	<	<	20	21	24
	900	1907	7	<	<	15	22	23	26	<	<	15	21	23	26
	1000	2119	8	-	-	-	-	-	-	<	<	16	24	25	28
6-14	500	1060	4	-	-	-	-	-	-	<	<	<	16	17	22
	600	1271	5	<	<	<	<	<	21	<	<	<	16	18	23
	700	1483	5	<	<	<	16	17	22	<	<	<	18	19	24
	800	1695	6	<	<	<	20	21	25	<	<	<	20	20	25
	900	1907	7	<	<	16	22	23	27	<	<	15	22	23	27
	1000	2119	8	<	15	17	24	25	29	<	<	16	23	25	28
	1100	2331	8	15	16	18	25	27	30	15	16	17	25	26	30
	1200	2543	9	16	18	20	27	28	32	16	17	18	26	28	31
6-16	1300	2755	10	17	18	20	28	29	33	16	17	19	27	28	32
	500	1060	4	-	-	-	-	-	-	<	<	<	15	16	21
	600	1271	5	<	<	<	<	16	21	<	<	<	15	17	22
	700	1483	5	<	<	<	17	18	23	<	<	<	17	19	23
	800	1695	6	<	<	16	20	21	25	<	<	<	19	21	25
	900	1907	7	<	<	15	22	23	26	<	<	15	21	22	26
	1000	2119	8	<	<	17	23	25	28	<	<	16	22	23	27
	1100	2331	8	15	16	18	24	26	29	<	15	17	24	25	28
	1200	2543	9	<	17	18	26	27	31	<	15	18	25	27	30
	1300	2755	10	17	17	19	28	29	32	16	16	19	26	27	31
1400	2967	10	18	18	20	29	30	32	-	-	-	-	-	-	

70 % primary air
< denotes < NC 15

Trox Acoustic Discharge Noise Performance Notes:

(one outlet in calculated space)

- Environmental adjustment factor
- Flow division (max. flow per outlet 300 CFM)
- Insertion loss of lined rectangular duct 12" x 12" (305 x 305 mm)
Ductlength 5 ft. (1.52 m)
- Insertion loss of lined circular flexible duct 8"
Ductlength 6 ft. (1.83 m)
Endreflection (Outlet 12" x 12") (305 x 305 mm)
- Space effect
Distance 10 ft. (3.05 m)
Roomvolume 5000 ft³. (141.6 m³)

Trox Acoustic Radiated Noise Performance Notes:

(one box in calculated space)

- Environmental adjustment factor
- Ceiling/Space Effect
3 ft. deep ceiling cavity
5/8" thick 20 lb./ft³. mineral fiber ceiling tile
- Space effect
Distance 10 ft. (3.05 m)
Roomvolume 5000 ft³. (141.6 m³)

Quick Selection Acoustic, Size 7

Estimated (occupied) Space NC Sound Levels

(procedure see ARI Standard 558-1998 + Addendum 2002)

Unit Size	Fan Flow-Rate		Flow division: Number of outlets	External static pressure Δp_{ex}													
				50 Pa						100 Pa							
	l/s			CFM		Discharge noise			Radiated noise			Discharge noise			Radiated noise		
						Inlet static pressure Δp_{in}											
				100	200	500	100	200	500	100	200	500	100	200	500		
7-12	900	1907	7	<	<	<	19	20	23	-	-	-	-	-	-		
	1000	2119	8	<	<	15	22	23	26	<	16	16	24	25	27		
	1100	2331	8	16	17	19	25	27	28	17	18	19	27	27	29		
	1200	2543	9	18	19	20	27	29	31	18	19	20	29	29	31		
	1300	2755	10	18	20	21	29	30	32	19	21	22	30	31	33		
7-14	900	1907	7	<	<	<	19	20	25	-	-	-	-	-	-		
	1000	2119	8	<	<	16	22	24	27	<	15	16	24	25	28		
	1100	2331	8	16	17	19	25	26	29	17	18	19	27	27	30		
	1200	2543	9	18	20	21	28	29	31	18	19	21	29	30	32		
	1300	2755	10	19	21	22	29	30	33	19	20	22	30	31	33		
	1400	2967	10	21	22	24	30	32	35	23	24	25	33	33	36		
	1500	3179	11	21	23	24	32	33	35	23	24	25	33	35	37		
	1600	3391	12	22	23	25	33	35	37	23	24	26	34	35	37		
	1700	3602	13	23	24	26	35	37	39	24	25	27	35	37	39		
7-16	900	1907	7	<	<	<	18	20	26	-	-	-	-	-	-		
	1000	2119	8	<	<	15	22	23	28	<	15	16	22	24	28		
	1100	2331	8	15	16	18	25	26	30	17	17	18	26	27	30		
	1200	2543	9	18	19	20	27	28	31	18	19	20	28	29	32		
	1300	2755	10	19	20	21	29	30	33	19	20	21	29	30	33		
	1400	2967	10	21	21	23	31	31	34	22	23	24	32	33	35		
	1500	3179	11	21	22	24	32	33	36	22	23	24	33	34	36		
	1600	3391	12	22	23	25	33	34	36	23	24	25	34	35	37		
	1700	3602	13	25	25	27	36	37	39	24	25	26	36	37	39		
	1800	3814	13	26	26	28	37	38	40	25	26	27	37	38	40		
	1900	4026	14	26	27	28	38	38	41	26	27	28	38	39	41		
2000	4238	15	27	27	29	39	40	42	26	27	29	39	39	41			

70 % primary air
< denotes < NC 15

Trox Acoustic Discharge Noise Performance Notes:

(one outlet in calculated space)

- Environmental adjustment factor
- Flow division (max. flow per outlet 300 CFM)
- Insertion loss of lined rectangular duct 12" x 12" (305 x 305 mm)
Ductlength 5 ft. (1.52 m)
- Insertion loss of lined circular flexible duct 8"
Ductlength 6 ft. (1.83 m)
Endreflection (Outlet 12" x 12") (305 x 305 mm)
- Space effect
Distance 10 ft. (3.05 m)
Roomvolume 5000 ft³. (141.6 m³)

Trox Acoustic Radiated Noise Performance Notes:

(one box in calculated space)

- Environmental adjustment factor
- Ceiling/Space Effect
3 ft. deep ceiling cavity
5/8" thick 20 lb./ft³. mineral fiber ceiling tile
- Space effect
Distance 10 ft. (3.05 m)
Roomvolume 5000 ft³. (141.6 m³)

Fan Performance, Size 2

High Tap

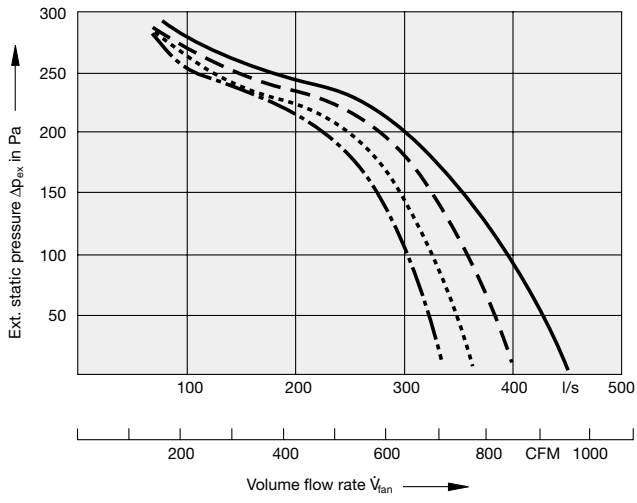

Standard Tap

— 230 VAC

Taps with optional Transformer

- - - 215 VAC

..... 200 VAC

- · - · 185 VAC

Medium Tap

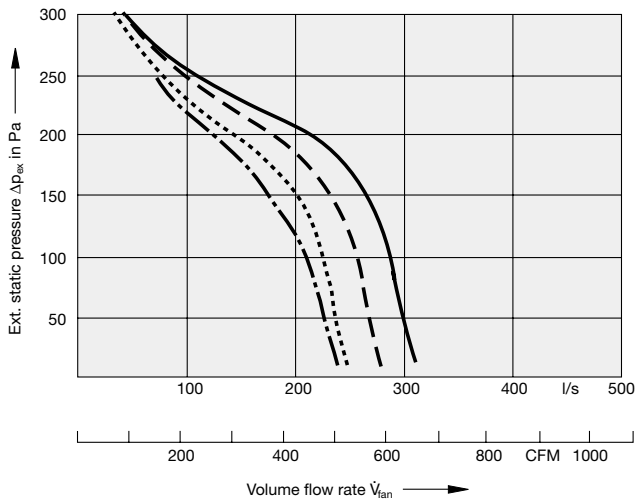

Low Tap

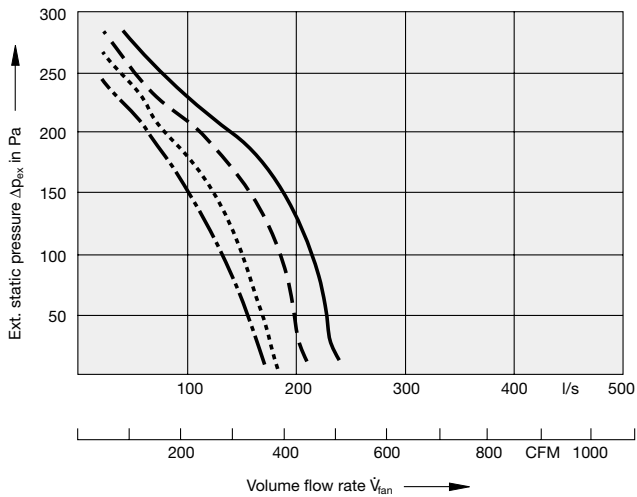

Acoustical Data, Size 2

Discharge Sound Power Levels in Decibels · External static pressure Δp_{ex} 50 Pa

Fan only

Fan Flow-Rate		Discharge Sound Power Levels in Decibels					
		f_m in Hz					
l/s	CFM	125	250	500	1000	2000	4000
150	318	49	47	49	52	48	43
200	424	53	50	52	55	52	48
250	530	55	53	55	57	55	52
300	636	61	60	58	62	61	58
350	742	63	62	61	63	62	60
400	848	65	64	63	65	64	62

Unit Size	Fan Flow-Rate		Inlet static pressure Δp_m																	
			100 Pa						200 Pa						500 Pa					
	l/s	CFM	f_m in Hz																	
			125	250	500	1000	2000	4000	125	250	500	1000	2000	4000	125	250	500	1000	2000	4000
2-05	150	318	47	52	50	50	46	40	48	54	50	50	46	40	49	53	51	51	47	41
	200	424	55	56	55	56	54	51	54	56	54	56	53	49	55	57	55	56	54	49
2-06	150	318	51	48	50	52	49	43	50	49	51	52	49	44	51	52	52	52	49	44
	200	424	55	52	54	56	54	50	56	55	55	58	56	52	57	56	56	58	56	53
	250	530	58	57	56	59	58	55	59	57	57	59	58	55	61	60	59	61	60	57
	300	636	61	60	59	62	61	59	62	61	59	62	61	59	64	63	61	64	63	61
	350	742	64	64	63	64	63	61	64	64	63	65	64	62	66	65	64	66	65	63
400	848	67	67	65	66	66	64	67	67	65	66	66	64	68	67	65	66	66	65	
2-08	150	318	48	49	50	51	47	43	49	50	51	51	47	43	50	53	52	52	48	43
	200	424	55	54	54	57	54	51	55	56	55	57	54	51	56	57	56	58	55	52
	250	530	56	57	57	59	56	54	57	58	57	59	57	55	59	60	59	61	58	56
	300	636	60	61	60	62	60	58	61	62	60	63	61	59	62	63	62	64	62	60
	350	742	62	63	62	64	62	61	63	64	63	65	63	62	65	66	64	66	64	63
400	848	64	66	64	66	65	63	66	67	65	67	65	64	67	68	66	67	66	65	

70 % primary air

Test data are obtained in accordance with ARI Standard 880 for Air Terminals (September 2002)

Sound power levels do not exceed the above values in each octave band with more than ARI rating tolerance:

Hz	125	250	500	1000	2000	4000
dB	6	4	3	3	3	3

Acoustical Data, Size 2

Discharge Sound Power Levels in Decibels · External static pressure Δp_{ex} 100 Pa

Fan only

Fan Flow-Rate		Discharge Sound Power Levels in Decibels					
		f_m in Hz					
l/s	CFM	125	250	500	1000	2000	4000
150	318	49	47	49	52	48	43
200	424	53	50	52	55	52	48
250	530	55	53	55	57	55	52
300	636	61	60	58	62	61	58
350	742	63	62	61	63	62	60
400	848	65	64	63	65	64	62

Unit Size	Fan Flow-Rate		Inlet static pressure Δp_{in} 100 Pa							Inlet static pressure Δp_{in} 200 Pa							Inlet static pressure Δp_{in} 500 Pa						
			Octave Sound Power Levels							Octave Sound Power Levels							Octave Sound Power Levels						
	l/s	CFM	125	250	500	1000	2000	4000	125	250	500	1000	2000	4000	125	250	500	1000	2000	4000			
2-05	150	318	51	54	51	53	50	45	50	55	51	53	49	44	51	54	52	53	50	44			
	200	424	56	57	55	57	55	51	56	57	55	57	55	51	56	58	55	57	55	51			
2-06	150	318	53	51	53	55	52	48	54	51	53	55	52	48	53	53	53	55	52	47			
	200	424	57	55	55	58	56	53	57	56	55	59	57	53	58	57	57	59	57	54			
	250	530	60	58	57	60	59	56	60	59	58	61	60	57	61	60	59	62	61	58			
	300	636	62	61	60	63	62	59	63	61	60	63	62	60	63	63	61	64	63	61			
	350	742	65	64	62	64	64	62	65	64	62	65	64	62	66	65	63	65	65	63			
400	848	67	66	64	66	65	63	66	65	64	65	65	63	67	66	64	66	66	64				
2-08	150	318	51	51	52	54	50	46	51	52	52	54	50	46	52	53	53	54	51	47			
	200	424	55	56	55	58	55	52	57	56	56	58	55	52	57	57	57	59	56	53			
	250	530	59	59	58	60	58	56	59	60	58	61	59	57	60	61	60	62	60	57			
	300	636	61	62	60	63	61	59	62	63	61	63	62	60	63	65	62	64	63	61			
	350	742	64	65	63	65	64	62	65	66	63	66	64	63	65	67	64	66	65	63			
400	848	65	66	64	66	65	64	66	66	67	64	66	65	64	67	68	65	67	66	65			

70 % primary air

Test data are obtained in accordance with ARI Standard 880 for Air Terminals (September 2002)

Sound power levels do not exceed the above values in each octave band with more than ARI rating tolerance:

Hz	125	250	500	1000	2000	4000
dB	6	4	3	3	3	3

Acoustical Data, Size 2

Radiated Sound Power Levels in Decibels · External static pressure Δp_{ex} 50 Pa

Fan only

Fan Flow-Rate		Radiated Sound Power Levels in Decibels					
		Octave Sound Power Levels					
l/s	CFM	125	250	500	1000	2000	4000
150	318	51	43	40	36	27	21
200	424	55	48	45	43	36	30
250	530	60	52	47	44	38	34
300	636	64	57	49	47	42	40
350	742	66	60	52	50	46	46
400	848	68	62	54	52	49	49

Unit Size	Fan Flow-Rate		Inlet static pressure Δp_{in} 100 Pa							Inlet static pressure Δp_{in} 200 Pa							Inlet static pressure Δp_{in} 500 Pa						
			Octave Sound Power Levels							Octave Sound Power Levels							Octave Sound Power Levels						
	l/s	CFM	125	250	500	1000	2000	4000	125	250	500	1000	2000	4000	125	250	500	1000	2000	4000			
2-05	150	318	49	48	42	38	32	27	50	51	43	39	36	34	52	52	48	42	44	47			
	200	424	56	53	47	43	38	35	58	55	48	44	40	37	58	57	50	45	45	47			
2-06	150	318	54	47	41	37	30	26	55	48	42	38	31	28	56	50	45	39	33	33			
	200	424	58	53	45	42	37	34	60	53	46	44	39	37	61	55	49	45	40	39			
	250	530	61	56	48	46	41	38	63	57	49	46	41	39	64	58	51	48	43	41			
	300	636	65	59	51	49	45	42	65	60	52	49	45	43	67	62	54	51	47	44			
	350	742	69	63	56	52	49	46	69	63	56	52	50	47	71	65	57	53	50	48			
400	848	72	66	58	54	52	48	72	66	59	54	51	49	73	67	60	54	51	50				
2-08	150	318	50	47	41	37	30	27	50	48	42	37	30	27	51	49	42	38	30	27			
	200	424	55	52	45	42	35	31	57	53	46	43	37	34	59	56	49	45	39	36			
	250	530	59	55	48	45	39	36	61	57	49	46	40	38	62	59	52	47	42	39			
	300	636	62	59	50	48	43	42	63	60	51	48	44	42	65	62	54	50	45	44			
	350	742	64	61	53	50	45	44	65	62	53	51	46	45	67	65	56	52	48	46			
400	848	66	63	54	52	47	46	67	64	55	52	48	47	69	67	57	53	49	48				

70 % primary air

Test data are obtained in accordance with ARI Standard 880 for Air Terminals (September 2002)

Sound power levels do not exceed the above values in each octave band with more than ARI rating tolerance:

Hz	125	250	500	1000	2000	4000
dB	6	4	3	3	3	3

Acoustical Data, Size 2

Radiated Sound Power Levels in Decibels · External static pressure Δp_{ex} 100 Pa

Fan only

Fan Flow-Rate		Radiated Sound Power Levels in Decibels					
		Octave Sound Power Levels					
l/s	CFM	125	250	500	1000	2000	4000
150	318	51	43	40	36	27	21
200	424	55	48	45	43	36	30
250	530	60	52	47	44	38	34
300	636	64	57	49	47	42	40
350	742	66	60	52	50	46	46
400	848	68	62	54	52	49	49

Unit Size	Fan Flow-Rate		Inlet static pressure Δp_{in} 100 Pa						Inlet static pressure Δp_{in} 200 Pa						Inlet static pressure Δp_{in} 500 Pa					
			Octave Sound Power Levels						Octave Sound Power Levels						Octave Sound Power Levels					
	l/s	CFM	125	250	500	1000	2000	4000	125	250	500	1000	2000	4000	125	250	500	1000	2000	4000
2-05	150	318	51	49	43	39	34	29	52	52	44	40	37	35	53	53	48	43	44	47
	200	424	58	54	47	44	39	35	58	55	49	45	41	38	58	57	50	46	45	47
2-06	150	318	56	49	44	40	34	30	56	50	44	41	34	32	57	52	47	42	36	35
	200	424	59	54	46	44	39	36	60	54	47	45	40	37	62	56	50	46	41	39
	250	530	62	56	49	46	41	38	64	57	50	48	42	40	65	59	52	48	44	41
	300	636	67	61	53	51	47	44	67	62	53	51	48	45	69	63	55	52	48	46
	350	742	70	64	56	53	53	47	70	64	56	53	53	47	72	66	58	54	51	49
400	848	71	66	58	54	53	49	72	66	58	54	54	49	73	67	60	55	53	50	
2-08	150	318	52	49	43	39	32	27	53	50	44	39	33	29	55	52	46	42	35	33
	200	424	56	53	46	43	37	33	57	54	47	43	38	35	59	56	49	45	39	37
	250	530	61	56	48	46	40	37	61	57	49	46	41	38	62	59	52	48	43	40
	300	636	63	59	51	49	44	42	64	60	52	49	45	43	65	62	54	50	46	44
	350	742	65	62	53	51	49	45	66	63	54	52	49	46	68	65	56	53	49	47
400	848	66	64	55	53	53	47	67	65	56	53	52	47	69	67	57	54	51	48	

70 % primary air

Test data are obtained in accordance with ARI Standard 880 for Air Terminals (September 2002)

Sound power levels do not exceed the above values in each octave band with more than ARI rating tolerance:

Hz	125	250	500	1000	2000	4000
dB	6	4	3	3	3	3

Fan Performance, Size 4

High Tap

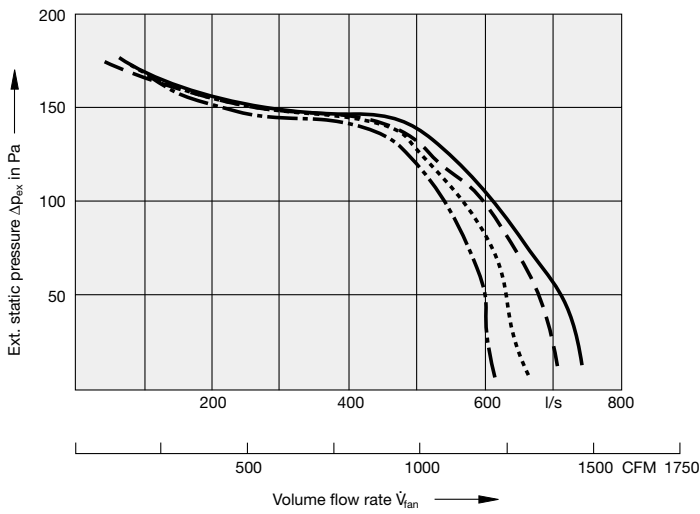

Standard Tap

— 230 VAC

Taps with optional Transformer

- - - 215 VAC

⋯ 200 VAC

- · - · 185 VAC

Medium Tap

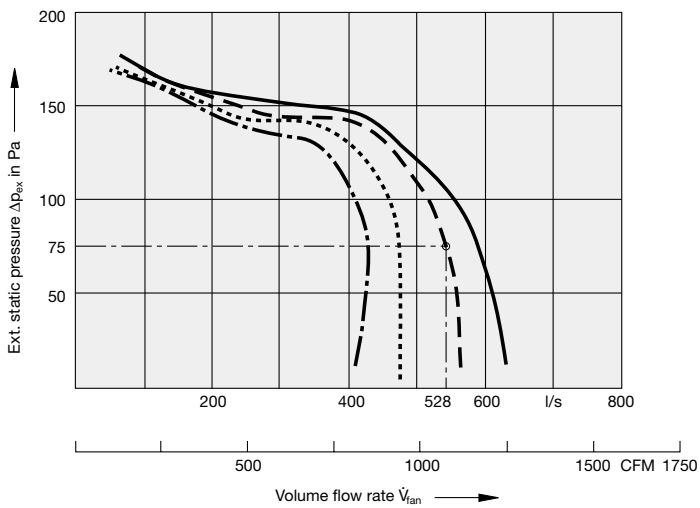

- - - - see example page 50

Low Tap

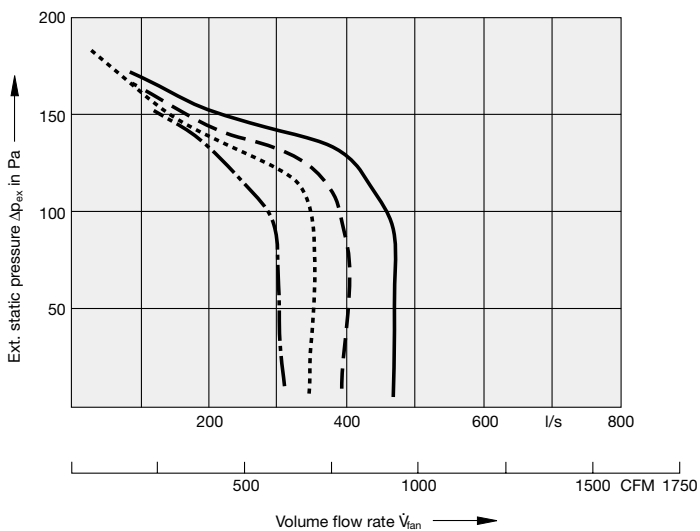

Acoustical Data, Size 4

Discharge Sound Power Levels in Decibels · External static pressure Δp_{ex} 50 Pa

Fan only

Fan Flow-Rate		Discharge Sound Power Levels in Decibels					
		Octave Sound Power Levels					
l/s	CFM	125	250	500	1000	2000	4000
300	636	52	53	54	54	50	45
350	742	55	56	58	57	54	49
400	848	56	57	59	59	55	52
450	954	58	59	61	60	57	55
500	1060	61	62	65	62	60	58
550	1166	61	63	66	63	61	59
600	1271	62	63	65	65	62	60
650	1377	63	65	68	66	64	62
700	1483	63	66	67	66	64	63

Unit Size	Fan Flow-Rate		Inlet static pressure Δp_{in} 100 Pa						Inlet static pressure Δp_{in} 200 Pa						Inlet static pressure Δp_{in} 500 Pa					
			Octave Sound Power Levels						Octave Sound Power Levels						Octave Sound Power Levels					
	l/s	CFM	125	250	500	1000	2000	4000	125	250	500	1000	2000	4000	125	250	500	1000	2000	4000
4-08	300	636	57	57	60	57	54	50	57	57	61	58	55	51	59	58	62	59	56	52
	350	742	58	58	62	59	56	52	60	59	62	59	57	53	61	61	65	61	58	55
	400	848	60	60	62	60	58	54	61	60	62	61	58	55	63	61	64	62	60	57
	450	954	61	60	62	61	59	56	63	62	63	62	60	57	64	63	64	63	60	58
	500	1060	63	62	63	63	60	57	64	65	64	63	61	58	66	66	65	64	62	59
	550	1166	64	64	64	64	62	59	65	65	65	64	62	60	67	67	65	65	63	61
4-10	300	636	56	57	59	58	54	50	57	58	60	58	55	51	60	59	60	60	56	53
	350	742	57	57	59	59	55	52	59	59	61	60	57	54	61	62	61	61	58	56
	400	848	60	60	62	61	58	55	61	61	63	62	59	56	62	63	63	63	60	58
	450	954	61	62	64	62	60	57	62	62	63	63	60	58	64	65	63	64	62	59
	500	1060	63	62	63	63	60	58	63	63	63	63	61	58	65	65	64	65	62	60
	550	1166	63	63	63	63	61	59	64	64	63	64	62	59	66	66	64	65	63	60
	600	1271	64	64	63	64	62	60	65	65	64	65	62	60	67	67	65	66	64	62
	650	1377	66	66	67	67	65	63	66	67	67	67	65	64	69	68	67	67	65	64
700	1483	66	67	67	67	65	64	68	67	66	67	65	63	68	69	67	67	65	64	
4-12	300	636	55	56	59	57	54	50	57	57	60	58	55	51	58	57	59	58	55	51
	350	742	58	58	62	60	57	54	59	59	61	60	57	54	60	60	61	61	58	55
	400	848	59	60	63	61	58	56	60	61	63	61	59	56	62	62	63	62	59	57
	450	954	60	61	63	62	60	57	61	62	63	63	60	58	64	64	65	64	62	60
	500	1060	62	62	64	63	61	59	63	63	64	64	62	60	65	65	65	65	63	61
	550	1166	64	63	64	64	62	60	64	64	65	65	63	61	66	66	66	66	64	62
	600	1271	65	65	65	65	63	61	65	65	65	65	63	62	67	67	67	67	65	64
	650	1377	65	65	66	66	64	62	66	66	66	66	64	63	68	69	68	68	66	65
700	1483	67	66	67	67	65	63	68	67	67	67	66	64	69	70	69	69	67	66	

70 % primary air

Test data are obtained in accordance with ARI Standard 880 for Air Terminals (September 2002)

Sound power levels do not exceed the above values in each octave band with more than ARI rating tolerance:

Hz	125	250	500	1000	2000	4000
dB	6	4	3	3	3	3

Acoustical Data, Size 4

Discharge Sound Power Levels in Decibels · External static pressure Δp_{ex} 100 Pa

Fan only

Fan Flow-Rate		Discharge Sound Power Levels in Decibels					
		Octave Sound Power Levels					
l/s	CFM	125	250	500	1000	2000	4000
300	636	52	53	54	54	50	45
350	742	55	56	58	57	54	49
400	848	56	57	59	59	55	52
450	954	58	59	61	60	57	55
500	1060	61	62	65	62	60	58
550	1166	61	63	66	63	61	59
600	1271	62	63	65	65	62	60
650	1377	63	65	68	66	64	62
700	1483	63	66	67	66	64	63

Unit Size	Fan Flow-Rate		Inlet static pressure Δp_{in} 100 Pa							Inlet static pressure Δp_{in} 200 Pa							Inlet static pressure Δp_{in} 500 Pa						
			Octave Sound Power Levels							Octave Sound Power Levels							Octave Sound Power Levels						
	l/s	CFM	125	250	500	1000	2000	4000	125	250	500	1000	2000	4000	125	250	500	1000	2000	4000			
4-08	300	636	57	57	61	58	55	51	58	58	62	58	55	51	60	59	63	59	57	53			
	350	742	59	58	61	59	56	53	60	59	61	60	57	53	61	60	63	61	58	55			
	400	848	60	60	62	60	58	54	61	60	62	61	58	55	63	62	63	62	59	56			
	450	954	62	61	62	62	59	56	62	62	62	62	59	56	64	63	64	63	61	58			
	500	1060	62	61	62	62	60	57	62	62	62	63	60	57	64	64	63	64	61	58			
4-10	300	636	58	58	60	59	55	52	59	58	60	59	56	52	60	59	60	60	57	53			
	350	742	58	58	60	59	56	53	60	60	60	60	57	54	61	61	61	61	58	55			
	400	848	60	60	61	61	58	55	61	61	61	61	59	56	63	63	62	63	60	57			
	450	954	61	61	62	62	59	57	62	62	62	63	60	57	65	65	63	64	61	58			
	500	1060	62	62	63	63	61	58	63	63	63	64	61	58	65	65	63	64	62	59			
	550	1166	63	63	63	64	61	59	64	64	63	64	62	59	66	65	64	65	62	60			
	600	1271	64	64	63	64	62	59	65	66	65	65	63	61	67	68	66	66	64	62			
650	1377	65	65	65	65	62	60	66	67	65	66	63	61	67	68	65	66	63	61				
4-12	300	636	57	57	60	58	55	51	58	58	60	59	56	52	58	58	60	59	56	52			
	350	742	58	59	62	60	57	53	58	59	62	60	57	54	60	60	61	61	58	55			
	400	848	60	60	63	61	59	56	60	61	63	62	59	57	62	62	63	62	60	57			
	450	954	61	61	63	62	60	57	61	62	63	63	60	58	64	64	64	64	61	59			
	500	1060	62	62	63	63	61	59	62	63	64	64	62	60	65	65	66	65	63	62			
	550	1166	63	63	64	64	62	60	64	64	65	65	63	61	65	66	66	66	64	62			
	600	1271	64	65	65	65	63	61	66	66	66	66	64	62	68	69	68	68	66	65			
	650	1377	65	65	65	65	64	62	66	66	66	66	65	63	68	69	68	68	66	65			

70 % primary air

Test data are obtained in accordance with ARI Standard 880 for Air Terminals (September 2002)

Sound power levels do not exceed the above values in each octave band with more than ARI rating tolerance:

Hz	125	250	500	1000	2000	4000
dB	6	4	3	3	3	3

Acoustical Data, Size 4

Radiated Sound Power Levels in Decibels · External static pressure Δp_{ex} 50 Pa

Fan only

Fan Flow-Rate		Radiated Sound Power Levels in Decibels					
		Octave Sound Power Levels					
l/s	CFM	125	250	500	1000	2000	4000
300	636	48	47	42	37	28	23
350	742	51	49	45	39	32	27
400	848	55	52	48	43	36	32
450	954	56	53	50	45	38	34
500	1060	59	55	52	47	41	37
550	1166	60	57	54	49	43	39
600	1271	63	59	57	51	46	42
650	1377	65	62	59	53	47	45
700	1483	66	63	59	54	48	46

Unit Size	Fan Flow-Rate		Inlet static pressure Δp_{in} 100 Pa						Inlet static pressure Δp_{in} 200 Pa						Inlet static pressure Δp_{in} 500 Pa					
			Octave Sound Power Levels						Octave Sound Power Levels						Octave Sound Power Levels					
	l/s	CFM	125	250	500	1000	2000	4000	125	250	500	1000	2000	4000	125	250	500	1000	2000	4000
4-08	300	636	53	50	46	40	33	29	56	52	47	41	35	31	59	56	50	44	39	37
	350	742	57	54	49	43	37	33	58	54	50	44	39	35	62	58	53	47	42	39
	400	848	59	55	51	46	40	36	61	57	53	47	41	38	64	60	57	49	44	41
	450	954	62	58	54	48	43	39	63	59	55	49	44	40	66	61	57	50	45	43
	500	1060	63	60	57	50	44	41	64	61	57	50	45	42	67	63	57	51	47	44
	550	1166	65	61	57	51	46	43	65	62	57	51	46	43	68	65	58	52	48	46
4-10	300	636	54	51	46	41	34	29	56	53	48	43	37	34	60	56	51	45	39	39
	350	742	57	54	49	44	38	34	59	55	51	45	40	37	62	59	53	47	42	40
	400	848	60	56	52	47	41	37	61	57	53	48	42	39	64	61	55	49	44	42
	450	954	61	57	53	48	42	38	62	59	54	49	43	40	65	61	55	50	45	42
	500	1060	63	59	55	50	44	40	64	60	55	50	45	41	66	63	56	51	46	43
	550	1166	64	60	56	51	46	42	65	61	56	51	46	42	67	64	57	52	46	44
	600	1271	65	61	58	52	47	43	66	63	57	52	47	44	68	65	58	53	48	45
	650	1377	66	63	59	54	48	45	67	64	59	54	49	46	69	66	59	54	49	47
700	1483	67	64	60	55	49	47	68	65	60	55	49	47	71	67	60	55	50	47	
4-12	300	636	52	50	45	39	33	30	53	51	46	40	34	35	57	55	50	44	39	42
	350	742	54	52	47	41	35	32	56	54	48	42	37	35	59	57	52	45	40	43
	400	848	58	55	51	45	39	35	59	57	51	46	40	38	61	60	54	47	42	44
	450	954	60	57	53	47	41	38	62	59	54	48	43	40	63	61	55	49	44	44
	500	1060	62	59	55	49	44	42	64	60	56	50	45	43	65	63	57	51	47	47
	550	1166	64	61	57	51	46	43	65	62	57	51	47	45	66	64	58	52	48	47
	600	1271	65	62	58	52	47	44	66	63	58	53	48	46	68	65	59	54	49	48
	650	1377	66	64	60	54	49	47	67	65	60	55	49	48	70	67	61	55	51	50
700	1483	67	65	61	55	50	49	68	66	61	56	51	49	71	68	62	56	52	50	

70 % primary air

Test data are obtained in accordance with ARI Standard 880 for Air Terminals (September 2002)

Sound power levels do not exceed the above values in each octave band with more than ARI rating tolerance:

Hz	125	250	500	1000	2000	4000
dB	6	4	3	3	3	3

Acoustical Data, Size 4

Radiated Sound Power Levels in Decibels · External static pressure Δp_{ex} 100 Pa

Fan only

Fan Flow-Rate		Radiated Sound Power Levels in Decibels					
		Octave Sound Power Levels					
l/s	CFM	125	250	500	1000	2000	4000
300	636	48	47	42	37	28	23
350	742	51	49	45	39	32	27
400	848	55	52	48	43	36	32
450	954	56	53	50	45	38	34
500	1060	59	55	52	47	41	37
550	1166	60	57	54	49	43	39
600	1271	63	59	57	51	46	42
650	1377	65	62	59	53	47	45
700	1483	66	63	59	54	48	46

Unit Size	Fan Flow-Rate		Inlet static pressure Δp_{in} 100 Pa							Inlet static pressure Δp_{in} 200 Pa							Inlet static pressure Δp_{in} 500 Pa						
			Octave Sound Power Levels							Octave Sound Power Levels							Octave Sound Power Levels						
	l/s	CFM	125	250	500	1000	2000	4000	125	250	500	1000	2000	4000	125	250	500	1000	2000	4000			
4-08	300	636	58	53	50	45	41	35	60	54	52	47	44	37	60	56	55	47	43	39			
	350	742	59	54	52	47	43	36	60	56	53	47	43	37	62	58	56	48	43	40			
	400	848	61	57	55	49	47	39	62	58	54	49	49	40	64	60	55	49	45	41			
	450	954	62	59	55	50	50	41	63	59	55	50	51	41	66	61	56	51	46	43			
	500	1060	64	60	55	51	52	42	64	61	56	51	51	43	66	63	56	51	47	44			
4-10	300	636	56	52	49	45	39	34	57	54	50	46	41	38	60	56	52	46	40	39			
	350	742	58	54	50	45	39	35	59	56	51	47	42	38	62	58	53	48	43	40			
	400	848	60	56	53	48	43	38	62	57	53	49	46	40	63	60	55	50	47	42			
	450	954	61	58	54	49	48	39	63	59	55	50	45	40	65	62	55	50	45	42			
	500	1060	63	59	55	50	49	41	64	60	55	51	48	42	66	62	56	51	46	43			
	550	1166	64	61	56	52	51	43	65	61	56	51	50	43	67	64	57	52	47	45			
	600	1271	66	62	58	53	51	44	67	62	57	53	50	44	69	65	58	53	48	46			
650	1377	66	63	58	54	51	45	67	64	58	54	50	45	69	66	58	54	48	46				
4-12	300	636	55	52	47	42	36	32	55	54	49	44	38	36	58	55	51	46	41	42			
	350	742	56	54	49	44	38	34	58	56	50	46	41	38	60	57	53	48	43	43			
	400	848	59	56	53	47	42	38	61	58	53	48	43	40	63	60	55	49	45	44			
	450	954	62	58	55	50	48	42	63	60	55	50	48	43	64	62	57	51	46	46			
	500	1060	63	60	56	51	50	43	64	61	56	51	50	44	66	63	58	52	50	47			
	550	1166	64	61	57	52	51	44	65	62	57	52	51	45	67	64	59	53	50	48			
	600	1271	66	63	58	54	52	46	67	64	59	54	51	46	69	67	60	55	50	49			
	650	1377	67	64	59	54	53	47	68	65	59	55	50	47	70	67	60	55	51	49			

70 % primary air

Test data are obtained in accordance with ARI Standard 880 for Air Terminals (September 2002)

Sound power levels do not exceed the above values in each octave band with more than ARI rating tolerance:

Hz	125	250	500	1000	2000	4000
dB	6	4	3	3	3	3

Fan Performance, Size 5

High Tap

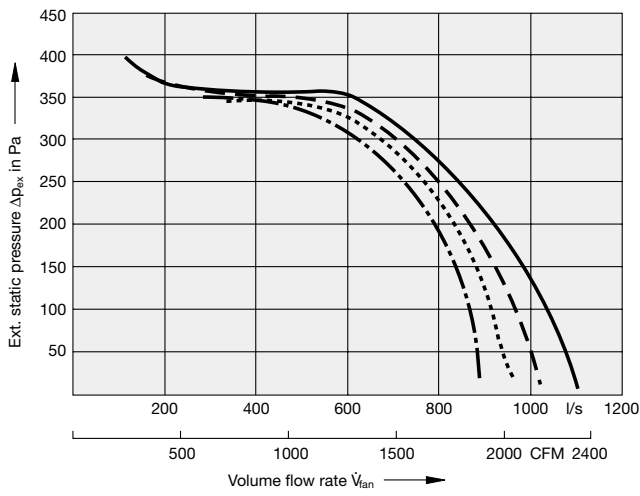

Standard Tap

— 230 VAC

Taps with optional Transformer

- - - 215 VAC

..... 200 VAC

- · - · 185 VAC

Medium Tap

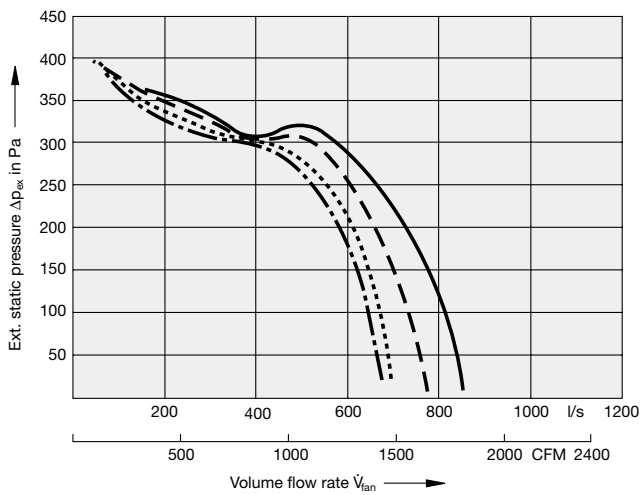

Low Tap

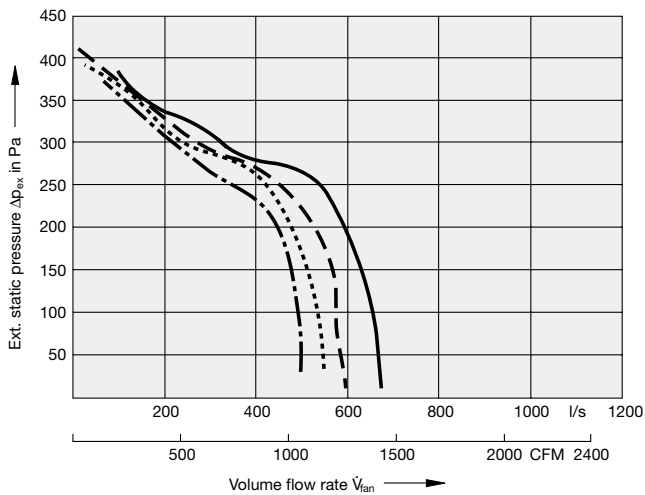

Acoustical Data, Size 5

Discharge Sound Power Levels in Decibels · External static pressure Δp_{ex} 50 Pa

Fan only

Fan Flow-Rate		Discharge Sound Power Levels in Decibels					
		Octave Sound Power Levels					
l/s	CFM	125	250	500	1000	2000	4000
450	954	56	57	60	59	58	55
500	1060	59	60	63	62	61	58
550	1166	61	62	66	65	63	62
600	1271	63	64	67	67	65	64
650	1377	65	66	68	68	67	66
700	1483	66	68	70	70	69	68
750	1589	67	69	71	71	70	70
800	1695	68	70	72	73	72	71
850	1801	69	72	73	75	73	73
900	1907	70	73	74	76	75	75
950	2013	72	74	75	77	76	76
1000	2119	73	75	75	78	77	77
1050	2166	75	77	76	80	78	78

Unit Size	Fan Flow-Rate		Inlet static pressure Δp_{in} 100 Pa						Inlet static pressure Δp_{in} 200 Pa						Inlet static pressure Δp_{in} 500 Pa					
	l/s	CFM	Octave Sound Power Levels						Octave Sound Power Levels						Octave Sound Power Levels					
			125	250	500	1000	2000	4000	125	250	500	1000	2000	4000	125	250	500	1000	2000	4000
5-10	450	954	64	61	63	63	60	58	64	62	64	64	61	58	64	62	64	64	61	58
	500	1060	65	63	65	65	63	60	65	64	65	65	63	61	66	64	65	66	63	61
	550	1166	66	65	67	67	65	63	67	66	67	68	65	63	68	67	68	68	66	64
	600	1271	67	68	68	69	67	65	68	68	68	69	67	65	69	68	69	69	67	65
	650	1377	68	68	69	70	68	66	69	69	69	70	68	66	70	70	70	71	69	67
	700	1483	70	70	70	71	69	68	70	70	71	72	70	68	72	71	71	72	70	69
	750	1589	71	71	71	72	70	69	71	71	72	72	71	69	72	72	72	73	71	70
	800	1695	71	72	72	73	72	70	72	72	72	73	72	70	73	73	73	74	72	71
	850	1801	72	73	74	75	73	72	73	74	74	75	73	72	74	74	74	75	74	73
900	1907	73	74	74	76	74	73	74	75	75	76	74	73	75	75	75	76	75	73	
5-12	450	954	62	61	63	62	60	57	62	61	63	63	60	57	62	61	63	62	60	57
	500	1060	64	63	64	65	62	60	64	63	65	65	62	60	65	63	65	65	63	60
	550	1166	66	65	67	67	65	63	66	66	67	67	65	63	67	66	67	67	65	63
	600	1271	67	67	68	69	66	65	68	67	68	69	67	65	68	68	68	69	67	65
	650	1377	68	68	69	70	68	66	69	69	69	70	68	66	70	69	70	70	68	67
	700	1483	69	69	70	71	69	68	70	69	71	71	69	68	70	70	71	72	70	69
	750	1589	70	70	71	72	70	69	71	71	72	73	71	69	72	72	72	73	71	70
	800	1695	71	71	72	73	71	70	71	71	73	74	72	71	72	73	73	74	72	71
	850	1801	72	73	74	75	73	72	72	73	74	75	73	72	74	74	75	76	74	73
	900	1907	73	74	74	76	74	73	73	74	75	76	74	73	74	75	75	76	75	74
	950	2013	73	74	75	76	75	74	74	75	75	77	75	74	75	75	76	77	75	74
1000	2119	74	75	76	77	76	75	74	75	76	77	76	75	76	77	77	77	76	75	
1050	2166	75	76	77	78	77	76	76	76	77	78	77	76	76	77	77	78	77	76	
5-14	450	954	61	61	63	62	60	58	61	62	63	63	60	58	63	62	64	64	61	59
	500	1060	63	63	65	65	63	61	64	64	66	65	63	62	65	65	66	66	64	62
	550	1166	66	66	67	67	65	64	66	66	68	68	66	64	68	68	68	68	66	65
	600	1271	67	68	69	69	67	67	68	68	69	69	68	67	70	70	70	70	68	67
	650	1377	69	70	70	71	69	68	69	70	70	71	69	68	70	71	71	71	70	69
	700	1483	69	71	71	72	71	70	70	72	72	72	71	70	71	73	73	73	71	71
	750	1589	70	72	73	73	72	72	71	73	73	73	72	71	73	74	74	74	73	72
	800	1695	72	73	74	75	73	73	72	74	74	75	73	73	74	75	75	75	74	73
	850	1801	73	75	75	76	75	75	74	75	76	76	75	75	75	77	77	77	76	75
	900	1907	74	76	76	77	76	76	75	77	77	77	76	76	76	78	77	78	77	76
	950	2013	74	77	77	78	77	77	75	78	77	78	77	77	76	79	78	78	77	77
	1000	2119	75	77	77	79	78	78	76	78	78	79	78	78	77	80	79	79	78	78
	1050	2166	76	78	78	80	79	79	76	79	79	80	79	79	78	80	80	80	80	79

70 % primary air

Test data are obtained in accordance with ARI Standard 880 for Air Terminals (September 2002)

Sound power levels do not exceed the above values in each octave band with more than ARI rating tolerance:

Hz	125	250	500	1000	2000	4000
dB	6	4	3	3	3	3

Acoustical Data, Size 5

Discharge Sound Power Levels in Decibels · External static pressure Δp_{ex} 100 Pa

Fan only

Fan Flow-Rate		Discharge Sound Power Levels in Decibels					
		Octave Sound Power Levels					
l/s	CFM	125	250	500	1000	2000	4000
450	954	56	57	60	59	58	55
500	1060	59	60	63	62	61	58
550	1166	61	62	66	65	63	62
600	1271	63	64	67	67	65	64
650	1377	65	66	68	68	67	66
700	1483	66	68	70	70	69	68
750	1589	67	69	71	71	70	70
800	1695	68	70	72	73	72	71
850	1801	69	72	73	75	73	73
900	1907	70	73	74	76	75	75
950	2013	72	74	75	77	76	76
1000	2119	73	75	75	78	77	77
1050	2166	75	77	76	80	78	78

Unit Size	Fan Flow-Rate		Inlet static pressure Δp_{in} 100 Pa						Inlet static pressure Δp_{in} 200 Pa						Inlet static pressure Δp_{in} 500 Pa					
			Octave Sound Power Levels						Octave Sound Power Levels						Octave Sound Power Levels					
	l/s	CFM	125	250	500	1000	2000	4000	125	250	500	1000	2000	4000	125	250	500	1000	2000	4000
5-10	500	1060	66	65	66	66	64	61	66	65	66	66	64	61	67	65	66	67	64	62
	550	1166	68	67	67	68	65	63	68	67	67	68	66	64	69	67	68	68	66	64
	600	1271	69	68	68	70	67	65	69	68	69	70	67	65	70	69	69	70	68	66
	650	1377	69	68	68	69	67	65	69	68	68	70	67	65	70	69	69	70	68	66
	700	1483	71	71	71	72	70	68	71	71	71	72	70	69	72	72	71	72	70	69
	750	1589	71	72	71	73	71	69	72	72	71	73	70	69	72	73	72	73	71	70
5-12	500	1060	65	64	65	66	63	61	65	64	65	66	63	61	66	65	66	66	64	61
	550	1166	66	65	66	67	65	63	67	66	66	67	65	63	67	66	67	68	65	63
	600	1271	68	68	68	69	67	65	68	68	68	69	67	65	69	69	69	70	67	66
	650	1377	67	67	68	69	67	65	68	68	69	69	67	65	69	68	69	70	68	66
	700	1483	70	71	71	72	70	68	71	71	71	73	70	69	72	71	72	73	71	69
	750	1589	71	71	71	73	71	69	71	71	71	73	71	69	72	72	72	73	71	70
	800	1695	72	72	72	74	72	70	72	72	72	74	72	70	73	73	73	74	72	71
	850	1801	72	73	73	74	72	71	72	73	73	75	73	71	74	74	74	75	73	72
	900	1907	73	74	74	75	73	72	73	74	74	75	74	72	74	75	75	76	74	73
	950	2013	73	74	74	76	74	73	74	74	75	76	75	73	75	76	75	76	75	74
1000	2119	75	75	75	76	75	74	74	75	75	77	75	74	75	76	76	77	76	75	
1050	2166	75	75	75	77	76	74	75	76	76	77	76	74	76	76	76	77	76	75	
5-14	500	1060	64	64	66	66	64	62	64	64	66	66	64	62	66	66	67	67	65	63
	550	1166	66	68	68	68	66	65	66	68	68	68	66	65	68	68	68	69	67	66
	600	1271	68	69	70	70	68	68	68	69	70	70	68	68	69	70	71	71	69	68
	650	1377	68	69	70	70	68	67	68	69	70	70	68	67	70	71	71	71	69	68
	700	1483	72	73	72	74	72	72	72	72	73	72	74	72	72	72	74	74	73	72
	750	1589	71	74	73	75	73	72	71	74	73	75	73	72	73	75	74	75	74	73
	800	1695	72	75	74	75	74	74	72	75	74	75	74	74	74	76	75	76	75	74
	850	1801	73	75	75	76	75	75	73	75	75	76	75	75	75	77	76	77	76	75
	900	1907	74	76	76	77	76	76	74	76	76	77	76	76	76	78	77	78	77	76
	950	2013	74	77	76	78	77	76	74	77	76	78	77	76	76	78	78	78	77	77
	1000	2119	75	78	77	78	78	77	75	78	77	78	78	77	77	79	79	79	79	78
	1050	2166	75	79	77	79	78	78	75	79	77	79	78	78	78	78	80	79	80	79

70 % primary air

Test data are obtained in accordance with ARI Standard 880 for Air Terminals (September 2002)

Sound power levels do not exceed the above values in each octave band with more than ARI rating tolerance:

Hz	125	250	500	1000	2000	4000
dB	6	4	3	3	3	3

Acoustical Data, Size 5

Radiated Sound Power Levels in Decibels · External static pressure Δp_{ex} 50 Pa

Fan only

Fan Flow-Rate		Radiated Sound Power Levels in Decibels					
		Octave Sound Power Levels					
l/s	CFM	125	250	500	1000	2000	4000
450	954	59	53	50	45	39	34
500	1060	61	56	53	47	42	40
550	1166	63	58	55	50	44	42
600	1271	65	60	57	52	46	44
650	1377	66	62	58	53	48	45
700	1483	69	63	60	55	49	47
750	1589	70	65	60	56	51	49
800	1695	72	66	62	58	52	50
850	1801	74	67	63	60	54	53
900	1907	75	68	64	61	55	54
950	2013	76	69	64	63	56	55
1000	2119	77	71	65	64	58	56
1050	2166	78	72	66	65	59	57

Unit Size	Fan Flow-Rate		Inlet static pressure Δp_{in} 100 Pa							Inlet static pressure Δp_{in} 200 Pa							Inlet static pressure Δp_{in} 500 Pa						
			Octave Sound Power Levels							Octave Sound Power Levels							Octave Sound Power Levels						
	l/s	CFM	125	250	500	1000	2000	4000	125	250	500	1000	2000	4000	125	250	500	1000	2000	4000			
5-10	450	954	63	58	53	49	43	39	63	59	54	49	44	40	64	59	54	50	46	42			
	500	1060	65	60	55	51	50	42	65	61	55	51	50	42	66	62	56	51	49	44			
	550	1166	67	62	57	53	51	45	68	63	57	53	51	46	69	65	58	54	51	47			
	600	1271	68	64	58	54	51	46	69	64	59	54	50	47	70	66	59	55	51	48			
	650	1377	69	64	59	55	50	47	70	66	60	55	51	48	71	67	60	56	52	49			
	700	1483	69	66	60	56	50	48	70	67	61	56	51	49	72	69	62	57	52	50			
	750	1589	70	67	62	57	52	50	71	68	62	57	52	50	73	70	63	58	53	52			
	800	1695	71	68	62	58	53	51	72	69	62	58	53	52	74	71	64	59	55	53			
	850	1801	71	67	62	59	54	52	76	71	64	60	55	53	75	71	65	61	56	54			
900	1907	73	70	64	61	55	54	74	71	65	61	56	54	76	73	65	62	57	55				
5-12	450	954	61	56	53	47	42	37	61	57	53	48	44	39	62	58	55	48	42	42			
	500	1060	63	58	54	49	43	40	64	59	55	49	44	41	64	60	56	50	48	44			
	550	1166	65	60	56	51	47	43	65	62	56	52	44	46	66	62	58	52	52	46			
	600	1271	67	62	57	53	51	45	67	63	58	53	51	46	68	65	59	54	53	48			
	650	1377	67	64	59	54	52	46	69	64	59	54	51	47	69	65	60	55	52	49			
	700	1483	68	64	60	55	50	48	70	66	61	56	51	48	71	67	61	56	52	50			
	750	1589	69	66	61	56	51	49	70	67	61	57	52	50	72	69	62	58	53	51			
	800	1695	71	67	62	58	53	50	71	68	62	58	53	51	73	70	63	59	54	52			
	850	1801	71	68	63	59	54	52	73	69	63	60	54	53	74	71	64	60	55	54			
	900	1907	73	69	64	60	55	53	74	70	64	61	56	54	75	72	65	61	56	55			
950	2013	74	70	65	61	56	54	74	71	65	62	57	55	76	73	66	62	57	56				
1000	2119	74	71	65	62	57	55	75	72	66	62	57	56	77	74	67	63	58	56				
1050	2166	76	72	67	64	59	57	76	73	67	64	59	57	78	75	68	64	59	58				
5-14	450	954	62	58	53	47	41	38	64	59	54	48	42	42	66	62	56	50	45	48			
	500	1060	65	61	56	50	44	41	66	62	56	51	45	44	68	64	59	53	47	49			
	550	1166	68	63	58	53	47	44	68	64	58	53	48	46	70	66	60	55	51	49			
	600	1271	69	65	59	55	49	47	69	66	60	55	50	48	72	68	61	56	51	50			
	650	1377	70	67	61	56	52	48	72	68	61	56	51	49	73	69	63	57	52	51			
	700	1483	71	67	62	57	52	49	72	68	63	58	52	50	74	70	64	59	53	52			
	750	1589	73	68	63	58	53	51	74	69	63	59	53	51	75	71	65	59	54	53			
	800	1695	74	69	64	60	54	52	75	70	64	60	55	53	76	73	66	61	55	54			
	850	1801	76	71	65	61	56	54	77	72	66	62	56	55	79	74	67	62	57	56			
	900	1907	77	71	66	62	57	55	78	73	66	63	57	56	79	75	68	63	58	57			
	950	2013	77	72	66	63	58	56	79	73	67	63	58	57	80	75	69	64	59	57			
1000	2119	78	73	67	64	59	57	79	74	68	64	59	57	81	76	69	65	60	58				
1050	2166	79	74	68	65	60	58	80	75	69	65	60	58	81	77	70	66	61	59				

70 % primary air

Test data are obtained in accordance with ARI Standard 880 for Air Terminals (September 2002)

Sound power levels do not exceed the above values in each octave band with more than ARI rating tolerance:

Hz	125	250	500	1000	2000	4000
dB	6	4	3	3	3	3

Acoustical Data, Size 5

Radiated Sound Power Levels in Decibels · External static pressure Δp_{ex} 100 Pa

Fan only

Fan Flow-Rate		Radiated Sound Power Levels in Decibels					
		Octave Sound Power Levels					
l/s	CFM	125	250	500	1000	2000	4000
450	954	59	53	50	45	39	34
500	1060	61	56	53	47	42	40
550	1166	63	58	55	50	44	42
600	1271	65	60	57	52	46	44
650	1377	66	62	58	53	48	45
700	1483	69	63	60	55	49	47
750	1589	70	65	60	56	51	49
800	1695	72	66	62	58	52	50
850	1801	74	67	63	60	54	53
900	1907	75	68	64	61	55	54
950	2013	76	69	64	63	56	55
1000	2119	77	71	65	64	58	56
1050	2166	78	72	66	65	59	57

Unit Size	Fan Flow-Rate		Inlet static pressure Δp_{in} 100 Pa						Inlet static pressure Δp_{in} 200 Pa						Inlet static pressure Δp_{in} 500 Pa					
			Octave Sound Power Levels						Octave Sound Power Levels						Octave Sound Power Levels					
	l/s	CFM	125	250	500	1000	2000	4000	125	250	500	1000	2000	4000	125	250	500	1000	2000	4000
5-10	500	1060	65	61	55	52	52	43	66	62	56	52	52	43	67	63	56	52	50	45
	550	1166	68	63	57	53	51	45	68	64	57	54	51	47	69	64	58	54	52	47
	600	1271	68	64	58	55	51	47	69	65	59	55	52	47	70	66	59	55	52	48
	650	1377	68	64	58	54	52	47	70	65	59	55	52	47	71	67	60	55	54	48
	700	1483	71	68	61	58	54	51	72	68	61	58	55	52	73	69	62	58	55	52
	750	1589	72	68	62	58	55	52	73	69	62	58	55	52	74	70	63	59	55	52
5-12	500	1060	64	59	55	50	49	42	64	60	55	51	52	43	65	61	57	51	52	45
	550	1166	66	61	56	52	52	44	66	62	57	52	52	45	67	63	58	53	50	47
	600	1271	67	63	58	54	51	47	68	64	58	54	51	47	69	65	59	55	52	49
	650	1377	67	63	58	53	52	46	68	64	59	54	53	47	70	66	60	54	53	48
	700	1483	70	66	61	58	54	51	71	67	62	58	54	51	72	69	62	58	54	52
	750	1589	71	67	62	58	54	51	72	68	62	58	55	52	73	69	63	59	55	52
	800	1695	72	68	62	59	55	52	73	69	63	59	55	52	74	70	64	60	56	53
	850	1801	72	69	63	60	56	53	73	70	63	60	56	53	75	71	64	60	56	54
	900	1907	73	70	64	61	56	54	74	70	64	61	56	54	76	72	65	61	57	55
	950	2013	74	70	65	62	57	55	76	71	65	62	57	55	77	73	66	62	57	55
1000	2119	76	72	65	62	58	56	77	72	66	62	58	56	78	74	67	63	58	56	
1050	2166	76	72	66	63	58	56	77	73	66	63	58	56	78	74	67	63	59	57	
5-14	500	1060	66	61	56	52	46	44	67	63	57	52	47	47	68	64	58	54	50	49
	550	1166	68	64	58	54	49	46	69	65	58	54	50	48	70	66	60	55	50	50
	600	1271	70	66	60	55	51	48	70	67	61	56	52	49	72	68	62	57	53	51
	650	1377	69	65	60	55	51	47	71	66	60	56	50	48	73	68	62	57	53	50
	700	1483	73	69	63	59	55	52	75	70	64	60	55	53	76	71	65	60	56	54
	750	1589	75	70	64	60	55	53	75	71	64	60	56	53	77	72	66	61	56	54
	800	1695	76	70	65	61	56	54	76	71	65	61	56	54	78	73	66	62	57	55
	850	1801	76	71	65	62	57	55	77	72	66	62	57	55	79	74	67	62	58	56
	900	1907	77	72	66	62	58	56	78	73	67	63	58	56	79	74	68	63	58	57
	950	2013	78	73	67	63	59	57	78	74	67	64	59	57	80	75	69	64	59	57
	1000	2119	78	73	68	64	59	57	79	74	68	64	59	58	81	76	69	65	60	58
	1050	2166	79	74	68	64	59	58	79	74	68	64	60	58	81	77	70	65	60	59

70 % primary air

Test data are obtained in accordance with ARI Standard 880 for Air Terminals (September 2002)

Sound power levels do not exceed the above values in each octave band with more than ARI rating tolerance:

Hz	125	250	500	1000	2000	4000
dB	6	4	3	3	3	3

Fan Performance, Size 6

High Tap

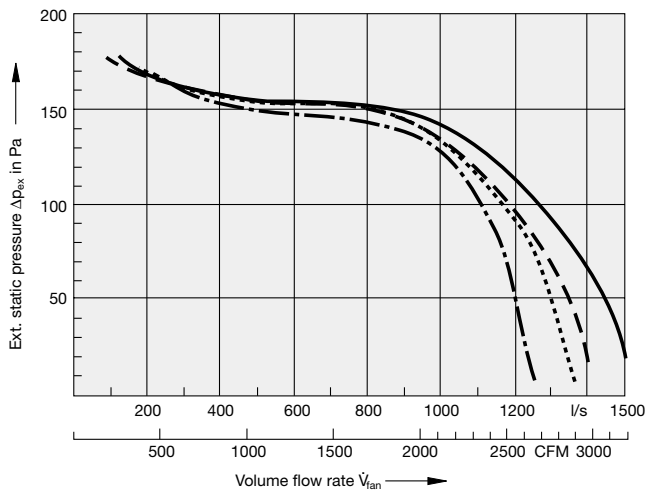

Standard Tap

— 230 VAC

Taps with optional Transformer

- - - 215 VAC

⋯ 200 VAC

- · - 185 VAC

Medium Tap

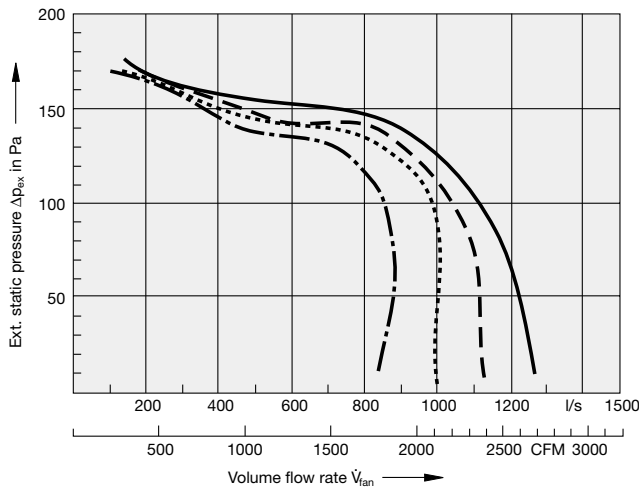

Low Tap

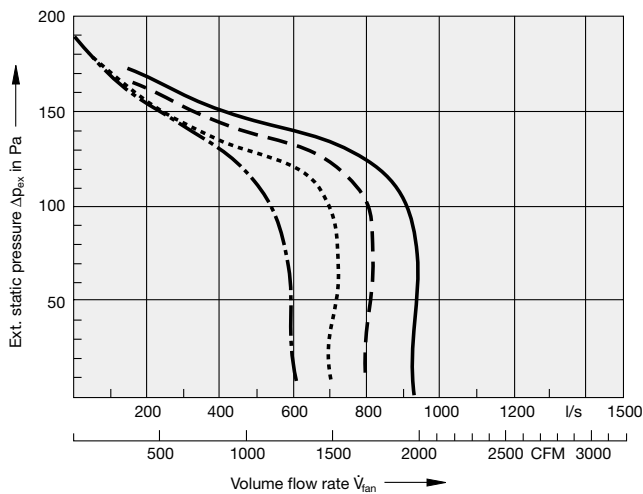

Acoustical Data, Size 6

Discharge Sound Power Levels in Decibels · External static pressure Δp_{ex} 50 Pa

Fan only

Fan Flow-Rate		Discharge Sound Power Levels in Decibels					
		Octave Sound Power Levels					
l/s	CFM	125	250	500	1000	2000	4000
600	1271	53	55	58	56	52	46
700	1483	57	58	60	60	56	51
800	1695	59	61	63	62	59	55
900	1907	61	63	65	64	61	57
1000	2119	62	64	66	66	62	59
1100	2331	63	65	66	66	63	60
1200	2543	63	65	66	67	64	60
1300	2755	64	66	67	67	65	61
1400	2967	65	67	67	68	66	62

Unit Size	Fan Flow-Rate		Inlet static pressure Δp_{in} 100 Pa						Inlet static pressure Δp_{in} 200 Pa						Inlet static pressure Δp_{in} 500 Pa					
			Octave Sound Power Levels						Octave Sound Power Levels						Octave Sound Power Levels					
	l/s	CFM	125	250	500	1000	2000	4000	125	250	500	1000	2000	4000	125	250	500	1000	2000	4000
6-12	600	1271	56	57	59	57	53	47	58	58	59	58	53	48	62	61	61	59	55	51
	700	1483	61	61	63	62	58	54	62	62	64	62	59	55	65	64	65	63	60	56
	800	1695	64	63	65	64	61	58	64	64	65	64	61	58	67	66	67	65	62	59
	900	1907	66	66	67	66	63	61	66	66	68	66	63	61	69	68	69	67	64	62
6-14	600	1271	57	58	60	58	54	49	59	59	61	59	55	50	63	63	63	62	58	54
	700	1483	60	61	62	61	57	54	61	61	63	61	57	54	66	65	65	64	60	57
	800	1695	63	63	65	64	61	58	64	65	66	65	61	58	67	67	68	66	63	60
	900	1907	65	66	67	66	63	60	66	66	68	66	63	61	69	69	69	68	65	62
	1000	2119	67	67	69	67	65	63	68	69	69	68	65	63	71	70	71	69	66	64
	1100	2331	68	69	70	68	66	64	69	70	71	69	66	64	72	71	71	70	67	65
	1200	2543	70	70	71	70	68	66	71	71	72	70	68	66	73	73	72	71	69	67
1300	2755	70	71	72	71	69	67	71	72	72	71	69	67	74	74	73	72	70	68	
6-16	600	1271	58	59	60	58	54	50	60	60	61	59	56	52	64	64	64	62	59	55
	700	1483	61	61	63	61	58	54	62	62	64	62	59	56	66	65	66	64	61	58
	800	1695	64	64	65	64	61	58	65	65	66	65	62	59	69	68	68	66	63	61
	900	1907	66	66	67	66	63	61	67	67	67	66	63	61	69	69	69	67	64	62
	1000	2119	67	67	69	67	65	63	69	68	68	67	65	62	71	70	70	68	65	63
	1100	2331	69	69	70	68	66	64	70	69	69	68	66	64	72	71	70	69	66	64
	1200	2543	68	68	68	68	65	63	71	71	70	69	67	65	73	72	71	70	67	65
	1300	2755	71	71	72	71	69	67	72	72	72	71	70	68	74	73	72	71	68	66
1400	2967	71	72	72	71	69	68	73	72	72	71	69	67	75	74	72	72	69	67	

70 % primary air

Test data are obtained in accordance with ARI Standard 880 for Air Terminals (September 2002)

Sound power levels do not exceed the above values in each octave band with more than ARI rating tolerance:

Hz	125	250	500	1000	2000	4000
dB	6	4	3	3	3	3

Acoustical Data Size 6

Discharge Sound Power Levels in Decibels · External static pressure Δp_{ex} 100 Pa

Fan only

Fan Flow-Rate		Discharge Sound Power Levels in Decibels					
		Octave Sound Power Levels					
l/s	CFM	125	250	500	1000	2000	4000
600	1271	53	55	58	56	52	46
700	1483	57	58	60	60	56	51
800	1695	59	61	63	62	59	55
900	1907	61	63	65	64	61	57
1000	2119	62	64	66	66	62	59
1100	2331	63	65	66	66	63	60
1200	2543	63	65	66	67	64	60
1300	2755	64	66	67	67	65	61
1400	2967	65	67	67	68	66	62

Unit Size	Fan Flow-Rate		Inlet static pressure Δp_{in} 100 Pa							Inlet static pressure Δp_{in} 200 Pa							Inlet static pressure Δp_{in} 500 Pa						
			Octave Sound Power Levels							Octave Sound Power Levels							Octave Sound Power Levels						
	l/s	CFM	125	250	500	1000	2000	4000	125	250	500	1000	2000	4000	125	250	500	1000	2000	4000			
6-12	500	1060	58	58	61	60	55	50	58	59	61	60	56	51	61	60	62	60	57	52			
	600	1271	60	60	63	61	57	53	61	61	63	61	58	53	63	62	64	62	59	55			
	700	1483	62	62	64	63	60	56	63	63	65	63	60	56	65	64	65	64	61	57			
	800	1695	64	64	66	65	62	58	65	65	67	65	62	59	68	66	67	66	63	59			
	900	1907	66	66	67	66	63	60	67	67	68	67	64	61	69	68	68	67	64	61			
	1000	2119	68	67	68	67	65	62	68	68	70	68	65	63	71	69	70	69	66	63			
6-14	500	1060	59	60	62	61	57	51	59	60	62	61	57	52	62	61	63	61	58	53			
	600	1271	61	61	63	62	58	54	61	62	64	62	59	54	64	63	64	63	59	55			
	700	1483	62	62	64	63	60	56	63	63	65	64	60	56	64	64	64	64	60	56			
	800	1695	64	64	65	64	61	58	65	65	66	65	62	58	67	67	67	66	63	59			
	900	1907	65	66	67	66	63	60	66	66	67	66	63	60	68	68	68	67	64	61			
	1000	2119	66	67	68	67	64	61	67	68	68	67	64	62	70	70	69	69	66	63			
	1100	2331	67	68	69	68	65	63	69	69	69	68	65	63	71	71	70	69	67	64			
1200	2543	69	70	70	69	67	65	70	71	70	70	67	65	72	72	71	71	68	65				
1300	2755	69	70	70	70	67	65	70	71	71	70	67	65	73	72	72	71	68	66				
6-16	500	1060	60	60	63	61	57	52	64	59	54	50	50	46	66	63	59	53	52	50			
	600	1271	61	61	63	62	58	54	65	61	55	50	50	47	68	64	60	54	52	50			
	700	1483	62	62	63	63	59	55	66	62	56	51	50	47	69	66	60	54	53	50			
	800	1695	64	64	65	64	61	57	68	64	57	51	50	47	71	67	61	54	53	51			
	900	1907	65	65	66	65	62	59	69	65	57	53	50	47	72	68	62	55	53	51			
	1000	2119	67	67	67	66	64	61	70	66	58	53	51	47	73	69	62	55	53	51			
	1100	2331	67	68	68	67	65	62	71	67	59	53	52	48	74	70	63	55	53	52			
	1200	2543	68	68	69	68	65	63	72	69	60	55	52	48	76	71	64	56	53	52			
1300	2755	69	70	69	69	66	64	70	70	69	69	66	64	73	72	71	70	67	65				

70 % primary air

Test data are obtained in accordance with ARI Standard 880 for Air Terminals (September 2002)

Sound power levels do not exceed the above values in each octave band with more than ARI rating tolerance:

Hz	125	250	500	1000	2000	4000
dB	6	4	3	3	3	3

Acoustical Data, Size 6

Radiated Sound Power Levels in Decibels · External static pressure Δp_{ex} 50 Pa

Fan only

Fan Flow-Rate		Radiated Sound Power Levels in Decibels					
		Octave Sound Power Levels					
l/s	CFM	125	250	500	1000	2000	4000
600	1271	53	51	45	37	27	23
700	1483	56	53	48	40	32	27
800	1695	60	56	51	44	37	33
900	1907	62	58	53	46	40	36
1000	2119	65	61	55	49	44	40
1100	2331	64	61	55	49	43	40
1200	2543	67	64	57	51	50	44
1300	2755	69	65	59	53	49	46
1400	2967	69	66	59	54	50	47

Unit Size	Fan Flow-Rate		Inlet static pressure Δp_{in} 100 Pa						Inlet static pressure Δp_{in} 200 Pa						Inlet static pressure Δp_{in} 500 Pa					
			Octave Sound Power Levels						Octave Sound Power Levels						Octave Sound Power Levels					
	l/s	CFM	125	250	500	1000	2000	4000	125	250	500	1000	2000	4000	125	250	500	1000	2000	4000
6-12	600	1271	60	57	50	44	36	32	61	58	51	45	43	36	65	63	58	51	47	44
	700	1483	64	60	52	46	41	36	64	61	53	47	44	39	68	65	59	52	48	45
	800	1695	67	63	55	49	44	41	67	64	56	50	45	41	71	67	60	53	49	46
	900	1907	68	65	56	50	45	42	70	66	57	51	46	44	72	68	61	53	49	47
6-14	600	1271	60	56	50	43	36	31	61	58	52	45	42	41	65	63	59	51	48	47
	700	1483	63	60	53	46	39	36	64	61	53	47	43	41	67	65	60	52	49	48
	800	1695	67	63	55	49	43	40	67	64	56	49	45	43	70	67	61	53	49	49
	900	1907	68	65	57	50	45	43	69	66	58	51	47	44	72	69	62	54	50	49
	1000	2119	70	66	59	51	47	44	71	67	60	53	48	45	74	71	63	55	50	50
	1100	2331	71	67	59	52	47	45	73	69	61	54	48	46	75	72	63	55	51	50
	1200	2543	73	69	60	53	49	47	74	70	61	55	50	48	77	73	65	57	52	51
1300	2755	74	70	62	55	50	49	75	71	62	56	51	49	78	74	65	57	53	52	
6-16	600	1271	62	58	51	44	39	35	63	60	53	46	43	43	67	64	58	52	49	48
	700	1483	64	60	53	47	42	38	65	62	54	48	44	44	69	66	60	53	50	49
	800	1695	67	63	55	49	45	41	68	64	57	50	46	45	71	67	61	54	50	50
	900	1907	68	65	57	50	45	43	69	66	58	51	46	45	72	69	62	54	50	50
	1000	2119	70	66	58	51	46	44	71	67	59	52	48	47	74	70	62	55	51	51
	1100	2331	70	67	58	52	47	45	71	68	60	53	48	47	74	71	63	55	51	51
	1200	2543	72	68	60	53	49	47	72	69	61	54	49	48	76	72	64	56	52	52
	1300	2755	73	70	61	54	49	48	74	71	61	55	50	49	76	73	64	56	52	52
1400	2967	74	71	61	55	50	49	75	72	62	56	51	50	77	74	65	57	53	53	

70 % primary air

Test data are obtained in accordance with ARI Standard 880 for Air Terminals (September 2002)

Sound power levels do not exceed the above values in each octave band with more than ARI rating tolerance:

Hz	125	250	500	1000	2000	4000
dB	6	4	3	3	3	3

Acoustical Data, Size 6

Radiated Sound Power Levels in Decibels · External static pressure Δp_{ex} 100 Pa

Fan only

Fan Flow-Rate		Radiated Sound Power Levels in Decibels					
		Octave Sound Power Levels					
l/s	CFM	125	250	500	1000	2000	4000
600	1271	53	51	45	37	27	23
700	1483	56	53	48	40	32	27
800	1695	60	56	51	44	37	33
900	1907	62	58	53	46	40	36
1000	2119	65	61	55	49	44	40
1100	2331	64	61	55	49	43	40
1200	2543	67	64	57	51	50	44
1300	2755	69	65	59	53	49	46
1400	2967	69	66	59	54	50	47

Unit Size	Fan Flow-Rate		Inlet static pressure Δp_{in} 100 Pa							Inlet static pressure Δp_{in} 200 Pa							Inlet static pressure Δp_{in} 500 Pa						
			Octave Sound Power Levels							Octave Sound Power Levels							Octave Sound Power Levels						
	l/s	CFM	125	250	500	1000	2000	4000	125	250	500	1000	2000	4000	125	250	500	1000	2000	4000			
6-12	500	1060	62	58	53	48	49	41	63	59	54	49	50	42	64	62	59	52	51	46			
	600	1271	63	60	54	49	50	42	64	61	55	51	50	43	67	64	60	53	52	47			
	700	1483	65	61	54	50	50	43	66	62	56	51	50	44	69	66	60	54	52	47			
	800	1695	67	63	56	51	50	44	67	64	57	52	51	45	71	67	61	54	52	48			
	900	1907	69	64	56	52	50	44	69	66	58	53	51	46	72	68	61	55	52	49			
	1000	2119	70	66	58	52	51	45	71	67	59	53	51	46	73	70	62	55	53	50			
6-14	500	1060	63	58	54	49	50	43	63	59	55	50	50	46	65	62	60	53	52	49			
	600	1271	64	60	54	49	50	43	65	61	56	51	50	46	67	64	61	54	52	49			
	700	1483	65	61	55	50	50	44	66	62	56	51	51	46	69	66	62	54	52	50			
	800	1695	66	63	56	51	50	45	68	64	57	52	51	47	70	67	62	55	52	50			
	900	1907	68	65	57	52	51	45	69	65	58	53	51	47	72	69	62	55	53	50			
	1000	2119	70	66	57	52	51	45	71	67	59	54	51	47	74	70	63	56	53	51			
	1100	2331	71	67	59	53	51	46	72	68	60	54	51	47	75	71	64	56	53	51			
1200	2543	72	68	60	53	51	46	73	69	61	55	52	48	76	72	64	57	54	51				
1300	2755	73	69	60	54	51	47	74	70	61	56	52	48	77	73	65	57	54	52				
6-16	500	1060	63	58	53	48	49	43	64	59	54	50	50	46	66	63	59	53	52	50			
	600	1271	64	59	53	49	50	44	65	61	55	50	50	47	68	64	60	54	52	50			
	700	1483	65	61	54	50	50	45	66	62	56	51	50	47	69	66	60	54	53	50			
	800	1695	67	63	55	50	50	44	68	64	57	51	50	47	71	67	61	54	53	51			
	900	1907	67	64	56	51	51	46	69	65	57	53	50	47	72	68	62	55	53	51			
	1000	2119	69	65	57	51	50	46	70	66	58	53	51	47	73	69	62	55	53	51			
	1100	2331	70	66	58	52	50	46	71	67	59	53	52	48	74	70	63	55	53	52			
	1200	2543	71	67	59	53	51	46	72	69	60	55	52	48	76	71	64	56	53	52			
1300	2755	72	68	59	53	51	47	73	69	60	55	52	49	76	72	64	56	53	52				

70 % primary air

Test data are obtained in accordance with ARI Standard 880 for Air Terminals (September 2002)

Sound power levels do not exceed the above values in each octave band with more than ARI rating tolerance:

Hz	125	250	500	1000	2000	4000
dB	6	4	3	3	3	3

Fan Performance, Size 7

High Tap

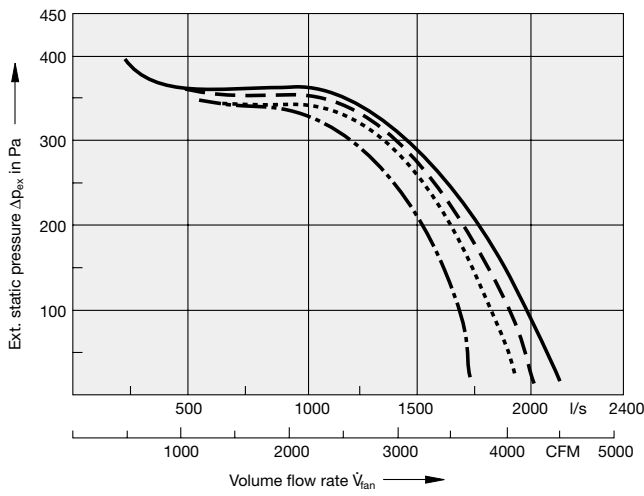

Standard Tap

— 230 VAC

Taps with optional Transformer

- - - 215 VAC

..... 200 VAC

- · - · 185 VAC

Medium Tap

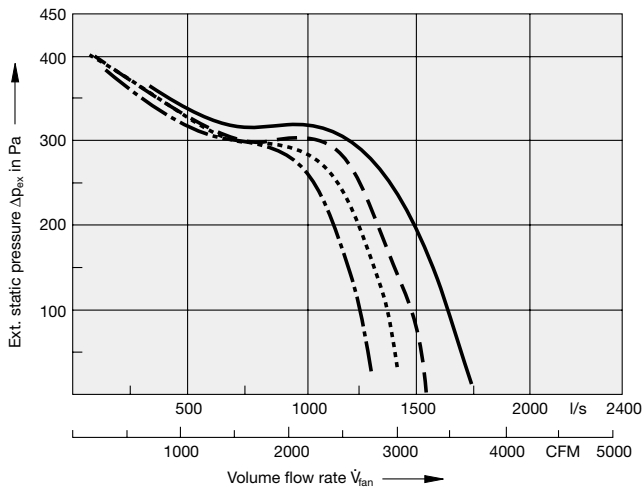

Low Tap

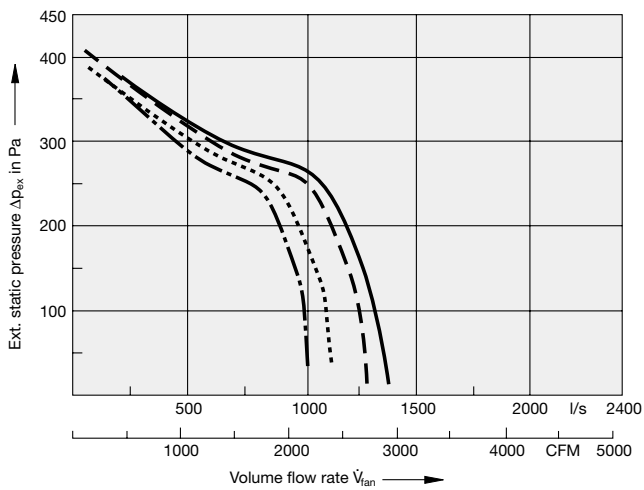

Acoustical Data, Size 7

Discharge Sound Power Levels in Decibels · External static pressure Δp_{ex} 50 Pa

Fan only

Fan Flow-Rate		Discharge Sound Power Levels in Decibels					
		Octave Sound Power Levels					
l/s	CFM	125	250	500	1000	2000	4000
900	1907	62	62	64	62	60	56
1000	2119	64	64	66	64	63	59
1100	2331	67	67	68	67	66	63
1200	2543	69	69	70	69	68	65
1300	2755	70	71	71	71	69	67
1400	2967	70	71	72	72	70	69
1500	3179	72	72	73	73	72	70
1600	3391	72	74	74	74	73	72
1700	3602	74	76	76	77	76	75
1800	3814	75	77	77	79	77	76
1900	4026	76	78	78	80	78	78
2000	4238	77	79	79	80	79	78

Unit Size	Fan Flow-Rate		Inlet static pressure Δp_{in} 100 Pa						Inlet static pressure Δp_{in} 200 Pa						Inlet static pressure Δp_{in} 500 Pa					
	l/s	CFM	Octave Sound Power Levels						Octave Sound Power Levels						Octave Sound Power Levels					
			125	250	500	1000	2000	4000	125	250	500	1000	2000	4000	125	250	500	1000	2000	4000
7-12	900	1907	65	65	66	64	62	59	67	65	66	64	62	59	68	66	66	64	62	59
	1000	2119	68	68	68	66	65	62	70	68	68	67	65	62	71	69	69	67	65	63
	1100	2331	70	70	70	69	67	65	71	71	71	69	68	65	73	72	71	70	68	66
	1200	2543	71	72	72	70	69	67	73	73	72	71	69	67	74	74	73	71	70	68
	1300	2755	73	73	73	72	70	68	74	74	73	72	71	69	76	75	74	73	71	69
7-14	900	1907	66	65	66	64	62	59	66	65	66	64	62	59	69	67	67	65	63	60
	1000	2119	68	67	68	66	65	62	68	68	68	66	65	62	70	70	69	67	65	63
	1100	2331	70	70	70	69	67	65	71	71	71	69	68	65	72	72	71	70	68	66
	1200	2543	72	72	72	71	69	67	73	73	73	71	70	68	74	74	73	72	70	68
	1300	2755	73	73	74	72	71	69	74	75	74	73	72	70	76	76	75	73	72	70
	1400	2967	74	75	74	73	72	70	76	76	75	74	72	71	77	77	76	74	73	71
	1500	3179	75	75	75	74	73	71	77	77	76	75	74	72	78	78	77	75	74	72
	1600	3391	76	77	76	76	74	73	77	77	77	76	75	73	80	79	78	76	75	73
	1700	3602	77	78	77	77	76	74	79	79	78	77	76	74	81	80	79	78	77	75
1800	3814	78	79	78	78	76	75	79	79	78	78	76	75	81	81	79	78	77	75	
7-16	900	1907	64	64	65	63	61	57	65	65	65	64	61	58	68	66	66	64	62	58
	1000	2119	67	67	68	66	64	61	68	67	68	66	65	62	69	69	69	67	65	62
	1100	2331	69	69	70	68	66	64	70	70	70	69	67	65	72	71	71	69	68	65
	1200	2543	71	72	72	70	69	67	72	72	72	71	69	67	74	73	73	71	70	68
	1300	2755	73	73	73	71	70	68	73	74	73	72	71	69	75	75	74	73	71	69
	1400	2967	74	74	75	73	72	70	75	75	75	74	72	71	76	77	76	74	73	71
	1500	3179	75	76	75	74	73	72	76	76	76	75	74	72	77	78	77	75	74	73
	1600	3391	76	77	76	76	74	73	77	78	77	76	75	73	78	79	78	76	75	74
	1700	3602	78	79	78	78	77	76	79	80	79	78	77	76	80	81	80	79	78	76
	1800	3814	79	80	79	79	78	76	80	81	79	79	78	77	81	82	80	79	78	77
	1900	4026	79	81	80	80	79	77	80	81	80	80	79	78	82	82	81	80	79	78
2000	4238	80	81	80	81	79	78	81	82	81	80	79	78	82	83	82	81	80	79	

70 % primary air

Test data are obtained in accordance with ARI Standard 880 for Air Terminals (September 2002)

Sound power levels do not exceed the above values in each octave band with more than ARI rating tolerance:

Hz	125	250	500	1000	2000	4000
dB	6	4	3	3	3	3

Acoustical Data, Size 7

Discharge Sound Power Levels in Decibels · External static pressure Δp_{ex} 100 Pa

Fan only

Fan Flow-Rate		Discharge Sound Power Levels in Decibels					
		Octave Sound Power Levels					
l/s	CFM	125	250	500	1000	2000	4000
900	1907	62	62	64	62	60	56
1000	2119	64	64	66	64	63	59
1100	2331	67	67	68	67	66	63
1200	2543	69	69	70	69	68	65
1300	2755	70	71	71	71	69	67
1400	2967	70	71	72	72	70	69
1500	3179	72	72	73	73	72	70
1600	3391	72	74	74	74	73	72
1700	3602	74	76	76	77	76	75
1800	3814	75	77	77	79	77	76
1900	4026	76	78	78	80	78	78
2000	4238	77	79	79	80	79	78

Unit Size	Fan Flow-Rate		Inlet static pressure Δp_{in} 100 Pa						Inlet static pressure Δp_{in} 200 Pa						Inlet static pressure Δp_{in} 500 Pa					
			Octave Sound Power Levels						Octave Sound Power Levels						Octave Sound Power Levels					
	l/s	CFM	125	250	500	1000	2000	4000	125	250	500	1000	2000	4000	125	250	500	1000	2000	4000
7-12	1000	2119	69	68	68	67	65	63	70	69	69	68	66	63	71	70	69	68	66	63
	1100	2331	70	70	70	69	67	65	72	71	71	70	68	66	73	72	71	70	68	66
	1200	2543	72	72	72	71	69	67	73	73	72	71	70	68	75	74	73	72	70	68
	1300	2755	73	73	73	72	70	69	74	74	73	73	71	69	76	76	74	73	72	70
7-14	1000	2119	69	68	69	67	66	63	70	69	69	68	66	63	71	70	69	68	66	64
	1100	2331	71	70	70	69	68	65	71	71	71	70	68	66	73	72	71	70	69	66
	1200	2543	72	72	72	71	70	67	73	73	72	71	70	68	75	74	73	72	70	68
	1300	2755	73	73	73	72	71	69	74	74	73	72	71	69	76	75	74	73	72	70
	1400	2967	76	76	76	75	74	72	77	77	76	75	74	72	79	78	77	76	75	73
	1500	3179	76	77	76	76	74	73	78	78	77	76	75	73	79	79	78	76	75	73
	1600	3391	77	77	77	76	75	73	78	78	77	76	75	73	80	79	78	77	76	74
1700	3602	77	78	77	77	76	74	79	79	78	78	76	75	81	81	79	78	77	75	
7-16	1000	2119	68	68	68	67	65	62	69	69	69	68	66	63	71	69	69	68	66	63
	1100	2331	70	70	70	69	67	65	71	70	70	70	68	65	72	71	71	70	68	66
	1200	2543	72	72	72	71	69	67	73	72	72	71	70	68	74	73	73	72	70	68
	1300	2755	73	73	73	72	71	69	74	74	73	73	71	69	75	75	74	73	72	69
	1400	2967	75	76	75	75	73	72	76	76	76	75	74	72	77	77	76	75	74	72
	1500	3179	76	76	76	75	74	72	76	77	76	76	74	73	78	78	77	76	75	73
	1600	3391	76	77	76	76	75	73	77	78	77	76	75	73	79	79	78	76	75	74
	1700	3602	78	79	78	78	76	75	78	79	78	78	77	75	80	80	79	78	77	75
	1800	3814	78	80	79	79	77	76	79	80	79	79	77	76	81	81	80	79	78	76
	1900	4026	79	81	79	80	78	77	80	81	80	79	78	77	82	82	81	80	79	78
2000	4238	81	81	80	81	79	78	81	82	81	81	79	78	82	83	81	80	80	78	

70 % primary air

Test data are obtained in accordance with ARI Standard 880 for Air Terminals (September 2002)

Sound power levels do not exceed the above values in each octave band with more than ARI rating tolerance:

Hz	125	250	500	1000	2000	4000
dB	6	4	3	3	3	3

Acoustical Data, Size 7

Radiated Sound Power Levels in Decibels · External static pressure Δp_{ex} 50 Pa

Fan only

Fan Flow-Rate		Radiated Sound Power Levels in Decibels					
		Octave Sound Power Levels					
l/s	CFM	125	250	500	1000	2000	4000
900	1907	63	56	51	44	39	35
1000	2119	65	59	53	47	42	39
1100	2331	67	62	56	50	45	43
1200	2543	68	64	57	52	48	46
1300	2755	69	65	59	54	51	48
1400	2967	72	69	60	57	56	53
1500	3179	72	69	60	57	53	51
1600	3391	73	70	61	58	55	53
1700	3602	75	72	63	60	56	55
1800	3814	75	73	64	60	57	56
1900	4026	76	74	65	61	58	57
2000	4238	77	74	65	62	58	58

Unit Size	Fan Flow-Rate		Inlet static pressure Δp_{in} 100 Pa							Inlet static pressure Δp_{in} 200 Pa							Inlet static pressure Δp_{in} 500 Pa						
			Octave Sound Power Levels							Octave Sound Power Levels							Octave Sound Power Levels						
	l/s	CFM	125	250	500	1000	2000	4000	125	250	500	1000	2000	4000	125	250	500	1000	2000	4000			
7-12	900	1907	67	62	54	48	43	41	68	63	55	50	45	42	71	66	59	52	49	46			
	1000	2119	70	65	57	50	46	44	70	65	58	52	47	45	73	68	60	53	50	48			
	1100	2331	72	67	59	53	49	47	73	69	60	54	50	48	75	70	62	55	52	50			
	1200	2543	74	69	60	55	50	49	75	70	61	55	51	50	76	72	63	57	53	52			
	1300	2755	75	71	62	56	52	51	76	72	63	57	52	52	77	73	64	58	54	53			
7-14	900	1907	67	62	54	48	43	41	68	63	55	49	45	43	71	67	59	53	49	49			
	1000	2119	70	65	57	51	46	44	71	66	58	52	48	46	73	69	61	54	51	50			
	1100	2331	72	67	59	53	49	47	73	69	60	54	49	48	75	71	62	55	52	51			
	1200	2543	74	70	61	55	51	49	75	71	61	56	52	50	77	73	63	57	54	52			
	1300	2755	75	71	62	56	52	51	76	72	62	57	53	51	78	74	64	58	54	53			
	1400	2967	76	72	63	57	53	52	77	73	64	58	54	53	79	76	66	59	56	55			
	1500	3179	77	73	64	58	54	54	78	74	65	59	55	55	80	76	66	60	56	56			
	1600	3391	77	74	65	60	55	55	79	76	66	60	56	55	81	77	67	61	57	57			
	1700	3602	79	76	66	61	57	57	80	77	67	62	58	57	82	79	69	62	59	58			
1800	3814	80	77	67	62	58	58	81	78	68	62	58	58	83	79	69	63	59	59				
7-16	900	1907	66	62	54	48	43	41	68	63	56	50	45	44	72	68	61	53	49	48			
	1000	2119	69	65	57	51	47	44	70	66	58	52	48	46	74	70	62	54	51	50			
	1100	2331	71	67	59	53	49	47	72	68	59	54	50	48	76	71	63	56	52	51			
	1200	2543	73	69	60	55	51	49	74	70	61	55	52	50	77	72	64	57	53	52			
	1300	2755	74	71	62	56	52	50	75	71	62	57	53	51	78	74	65	58	55	53			
	1400	2967	75	72	63	57	53	52	76	73	63	58	54	52	79	75	66	59	55	54			
	1500	3179	76	73	64	58	54	53	78	74	65	59	55	54	80	76	67	60	56	55			
	1600	3391	78	74	65	59	55	55	78	75	65	60	56	55	81	77	67	61	57	56			
	1700	3602	79	76	67	62	58	57	80	77	68	62	58	58	82	79	69	63	59	59			
	1800	3814	81	77	68	63	59	58	81	78	69	63	59	59	83	80	70	64	60	60			
	1900	4026	81	78	69	64	60	59	82	79	69	64	60	59	84	81	71	64	61	60			
2000	4238	82	79	69	64	60	60	83	80	70	64	61	60	84	81	71	65	61	61				

70 % primary air

Test data are obtained in accordance with ARI Standard 880 for Air Terminals (September 2002)

Sound power levels do not exceed the above values in each octave band with more than ARI rating tolerance:

Hz	125	250	500	1000	2000	4000
dB	6	4	3	3	3	3

Acoustical Data, Size 7

Radiated Sound Power Levels in Decibels · External static pressure Δp_{ex} 100 Pa

Fan only

Fan Flow-Rate		Radiated Sound Power Levels in Decibels					
		Octave Sound Power Levels					
l/s	CFM	125	250	500	1000	2000	4000
900	1907	63	56	51	44	39	35
1000	2119	65	59	53	47	42	39
1100	2331	67	62	56	50	45	43
1200	2543	68	64	57	52	48	46
1300	2755	69	65	59	54	51	48
1400	2967	72	69	60	57	56	53
1500	3179	72	69	60	57	53	51
1600	3391	73	70	61	58	55	53
1700	3602	75	72	63	60	56	55
1800	3814	75	73	64	60	57	56
1900	4026	76	74	65	61	58	57
2000	4238	77	74	65	62	58	58

Unit Size	Fan Flow-Rate		Inlet static pressure Δp_{in} 100 Pa						Inlet static pressure Δp_{in} 200 Pa						Inlet static pressure Δp_{in} 500 Pa					
			Octave Sound Power Levels						Octave Sound Power Levels						Octave Sound Power Levels					
	l/s	CFM	125	250	500	1000	2000	4000	125	250	500	1000	2000	4000	125	250	500	1000	2000	4000
7-12	1000	2119	71	66	58	54	51	47	72	67	59	54	52	47	74	69	61	55	53	50
	1100	2331	73	69	60	55	52	49	73	69	60	56	53	49	75	71	62	57	54	51
	1200	2543	74	70	61	57	54	51	75	71	62	57	54	51	77	73	64	58	56	53
	1300	2755	76	72	62	58	55	52	76	72	63	58	55	53	78	74	65	58	56	54
7-14	1000	2119	71	67	58	53	51	46	72	67	59	55	52	48	75	70	62	56	54	51
	1100	2331	73	69	60	55	53	49	74	69	60	56	53	50	76	72	63	57	55	52
	1200	2543	75	70	61	57	54	51	75	71	62	58	56	53	77	73	64	58	56	53
	1300	2755	76	72	62	57	55	52	77	72	63	58	55	53	78	74	65	59	56	54
	1400	2967	77	74	64	59	56	54	79	74	65	59	56	55	80	76	66	60	57	56
	1500	3179	78	74	65	60	56	55	79	75	66	60	57	56	81	77	67	61	58	57
	1600	3391	79	75	65	60	57	56	80	76	66	60	57	56	82	78	68	61	58	57
1700	3602	80	76	66	61	58	57	80	77	67	62	58	57	83	79	68	62	59	58	
7-16	1000	2119	70	65	57	52	51	46	71	66	58	54	51	48	75	70	63	56	53	50
	1100	2331	72	68	59	54	53	47	73	69	60	55	53	49	76	71	64	57	54	52
	1200	2543	74	70	61	55	54	50	74	70	61	56	54	50	77	73	64	57	55	53
	1300	2755	75	71	62	56	54	51	76	72	63	58	55	52	78	74	65	58	56	54
	1400	2967	77	73	64	59	56	54	77	74	64	60	56	54	80	76	66	60	57	56
	1500	3179	78	74	64	60	56	55	78	75	65	60	57	55	81	77	67	61	58	56
	1600	3391	78	75	65	60	57	55	79	76	66	60	57	56	81	77	68	61	58	57
	1700	3602	80	77	67	62	59	57	81	78	68	62	59	58	82	79	69	63	60	59
	1800	3814	81	77	68	63	59	58	82	78	68	63	60	59	83	80	70	64	60	60
	1900	4026	82	79	69	64	60	59	83	79	69	64	60	59	84	81	71	64	61	60
2000	4238	82	79	69	64	60	60	82	79	69	64	61	60	84	81	71	65	62	61	

70 % primary air

Test data are obtained in accordance with ARI Standard 880 for Air Terminals (September 2002)

Sound power levels do not exceed the above values in each octave band with more than ARI rating tolerance:

Hz	125	250	500	1000	2000	4000
dB	6	4	3	3	3	3

Hot Water Coil Performance Data

Size 2 and 4, 60 °C entering water

Standard Features

- Galvanized Steel Casing with Flanges on Two Sides
- Aluminum Rippled Tubular Fin, Spacing between each is 2.5 mm
- Copper Tubes with DN15, Upstream and Downstream connections are Standardized
- Max. Working Pressure is 16 bar
- Tubes are Transverse jointed

Optional Features

- Heat Coils are Pre-mounted on VAV Terminals
- Two or Three Way Hot Water Control Valves available with Pneumatic or Electric actuator

Notes (pages 45-46)

1. Data is based on 60 °C Entering Water Temperature (EWT) and 20 °C Entering Air Temperature (EAT) at sea level.
For EWT = 90 °C see pages 47 and 48. For other conditions contact your TROX representative for design assistance.
2. For optimum diffuser performance in overhead heating applications, the supply air temperature should be within 11 K of the desired space temperature. This typically requires a higher air flow rate, which provides higher air motion in the space, increasing thermal comfort. The hot water coil should be selected with this in mind, keeping the Leaving Air Temperature (LAT) as low as possible.

Sizes	Rows	Water Flow \dot{V}_w	Water Flow Resistance Δp_w	Air Flow \dot{V}		l/s	150	170	220	280	335	390
				Air Velocity v_a		CFM	318	360	466	593	710	826
						m/s	1.7	1.9	2.5	3.2	3.8	4.4
2-05 2-08	1	l/h	kPa	Air Flow Resistance Δp_a	Pa	11	15	25	38	53	67	
		108	0.02	Heat Output \dot{Q}	kW	0.62	0.65	0.69	0.72	0.75	0.79	
		216	0.05			0.82	0.87	0.96	1.02	1.07	1.16	
		540	0.26			1.08	1.16	1.32	1.43	1.53	1.73	
		1152	0.98			1.23	1.34	1.55	1.72	1.87	2.15	
	1980	2.54	1.31			1.44	1.69	1.88	2.05	2.42		
	2	l/h	kPa	Air Flow Resistance Δp_a	Pa	25	29	45	65	91	121	
		216	0.07	Heat Output \dot{Q}	kW	1.37	1.47	1.65	1.78	1.88	1.97	
		540	0.32			1.73	1.89	2.20	2.43	2.64	2.81	
		1152	1.20			1.94	2.15	2.56	2.88	3.17	3.43	
1980		3.11	2.05			2.28	2.75	3.13	3.46	3.77		
3060	5.03	2.10	2.35			2.84	3.25	3.61	3.93			

Sizes	Rows	Water Flow \dot{V}_w	Water Flow Resistance Δp_w	Air Flow \dot{V}		l/s	330	390	470	555	640	695	750
				Air Velocity v_a		CFM	699	826	996	1176	1356	1473	1589
						m/s	1.3	1.5	1.9	2.2	2.5	2.7	3.0
4-06 4-12	1	l/h	kPa	Air Flow Resistance Δp_a	Pa	14	19	25	35	47	60	68	
		108	0.02	Heat Output \dot{Q}	kW	1.10	1.14	1.18	1.22	1.25	1.27	1.29	
		216	0.06			1.52	1.60	1.68	1.76	1.82	1.88	1.91	
		540	0.29			2.08	2.24	2.38	2.55	2.62	2.80	2.88	
		1152	1.08			2.46	2.69	2.89	3.14	3.35	3.56	3.66	
	1980	2.80	2.66			2.93	3.17	3.48	3.74	3.98	4.14		
	2	l/h	kPa	Air Flow Resistance Δp_a	Pa	27	36	46	65	86	110	127	
		216	0.09	Heat Output \dot{Q}	kW	2.70	2.89	3.06	3.24	3.40	3.53	3.61	
		540	0.43			3.53	3.87	4.16	4.52	4.83	5.11	5.27	
		1152	1.63			4.05	4.50	4.91	5.43	5.89	6.29	6.54	
1980		4.19	4.32			4.84	5.31	5.92	6.48	6.98	7.27		
3060	6.79	4.45	5.00			5.50	6.16	6.77	7.33	7.64			

Hot Water Coil Performance Data

Size 5-7, 60 °C entering water

Sizes	Rows	Water Flow \dot{V}_w	Water Flow Resistance Δp_w	Air Flow \dot{V}		l/s	450	555	640	720	830	915	1000	1100
				Air Velocity v_a		CFM	954	1176	1356	1526	1759	1939	2119	2331
						m/s	1.2	1.5	1.7	1.9	2.2	2.4	2.7	2.9
5-08 5-14	1	l/h	kPa	Air Flow Resistance Δp_a	Pa	25	36	32	38	48	56	64	76	
		108	0.02	Heat Output \dot{Q}	kW	1.71	1.78	1.82	1.86	1.89	1.92	1.95	1.97	
		216	0.06			2.42	2.57	2.65	2.72	2.80	2.86	2.90	2.96	
		540	0.30			3.40	3.70	3.87	4.02	4.20	4.32	4.44	4.58	
		1152	1.14			4.08	4.53	4.79	5.04	5.34	5.53	5.71	5.94	
	1980	2.95	4.47			5.00	5.33	5.65	6.02	6.27	6.51	6.79		
	2	l/h	kPa	Air Flow Resistance Δp_a	Pa	45	67	59	70	89	103	118	141	
		216	0.09	Heat Output \dot{Q}	kW	4.37	4.73	4.90	5.08	5.30	5.41	5.52	5.66	
		540	0.46			5.90	6.53	6.91	7.27	7.70	7.97	8.22	8.51	
		1152	1.75			6.90	7.81	8.35	8.87	9.52	9.91	10.30	10.79	
1980		4.50	7.44			8.48	9.15	9.78	10.53	11.04	11.54	12.17		
3060	7.29	7.70	8.81			9.55	10.24	11.04	11.61	12.16	12.86			

Sizes	Rows	Water Flow \dot{V}_w	Water Flow Resistance Δp_w	Air Flow \dot{V}		l/s	600	695	830	970	1110	1250	1390	1500
				Air Velocity v_a		CFM	1271	1473	1759	2055	2352	2649	2945	3178
						m/s	1.2	1.4	1.6	1.9	2.2	2.5	2.7	3.0
6-10 6-16	1	l/h	kPa	Air Flow Resistance Δp_a	Pa	14	19	26	34	43	53	63	72	
		108	0.06	Heat Output \dot{Q}	kW	3.53	3.67	3.81	3.93	4.03	4.12	4.17	4.21	
		216	0.30			5.11	5.40	5.72	5.98	6.23	6.46	6.62	6.75	
		540	1.14			6.28	6.75	7.26	7.68	8.08	8.44	8.77	9.04	
		1152	2.95			6.95	7.56	8.18	8.75	9.23	9.71	10.17	10.54	
	1980	4.78	7.31			8.00	8.69	9.34	9.87	10.42	10.94	11.36		
	2	l/h	kPa	Air Flow Resistance Δp_a	Pa	27	35	48	63	80	98	117	133	
		216	0.46	Heat Output \dot{Q}	kW	9.05	9.73	10.47	11.07	11.57	12.01	12.39	12.69	
		540	1.75			10.86	11.84	12.94	13.83	14.67	15.45	16.10	16.62	
		1152	4.50			11.83	13.05	14.32	15.47	16.54	17.50	18.36	19.05	
1980		7.29	12.13			13.41	14.78	16.03	17.17	18.18	19.12	19.87		
3060	9.65	12.43	13.77			15.24	16.60	17.80	18.87	19.88	20.69			

Sizes	Rows	Water Flow \dot{V}_w	Water Flow Resistance Δp_w	Air Flow \dot{V}		l/s	900	1110	1250	1390	1530	1670	1805	1945	2100
				Air Velocity v_a		CFM	1907	2352	2649	2945	3242	3539	3825	4121	4450
						m/s	1.2	1.5	1.6	1.8	2.0	2.2	2.4	2.5	2.7
7-12 7-16	1	l/h	kPa	Air Flow Resistance Δp_a	Pa	13	20	24	29	34	39	45	51	58	
		108	0.35	Heat Output \dot{Q}	kW	8.70	9.31	9.65	9.90	10.15	10.33	10.51	10.69	10.86	
		216	1.32			11.10	12.08	12.61	13.11	13.51	13.92	14.27	14.61	14.95	
		540	3.39			12.56	13.80	14.52	15.20	15.68	16.26	16.77	17.27	17.78	
		1152	5.49			13.37	14.75	15.57	16.35	16.87	17.54	18.14	18.74	19.33	
	1980	8.13	14.18			15.69	16.62	17.50	18.06	18.83	19.52	20.20	20.89		
	2	l/h	kPa	Air Flow Resistance Δp_a	Pa	24	36	45	53	63	73	84	95	107	
		216	2.01	Heat Output \dot{Q}	kW	19.86	21.93	23.09	24.06	25.03	25.84	26.63	27.41	28.20	
		540	5.18			22.08	24.72	26.14	27.43	28.70	29.82	30.80	31.77	32.74	
		1152	8.39			22.84	25.65	27.17	28.56	29.94	31.18	32.21	33.24	34.27	
1980		12.35	23.59			26.59	28.19	29.70	31.19	32.53	33.62	34.71	35.80		
3060	17.08	23.97	27.06			28.70	30.27	31.81	33.21	34.33	35.45	36.56			

Hot Water Coil Performance Data

Size 2 and 4, 90 °C entering water

Notes (pages 47-48)

3. Data is based on 90 °C Entering Water Temperature (EWT) and 20 °C Entering Air Temperature (EAT) at sea level.
For EWT = 60 °C see pages 45 and 46. For other conditions contact your TROX representative for design assistance.
4. For optimum diffuser performance in overhead heating applications, the supply air temperature should be within 11 K of the desired space temperature. This typically requires a higher air flow rate, which provides higher air motion in the space, increasing thermal comfort. The hot water coil should be selected with this in mind, keeping the Leaving Air Temperature (LAT) as low as possible.

Sizes	Rows	Water Flow \dot{V}_w	Water Flow Resistance Δp_w	Air Flow \dot{V}		I/s	150	170	220	280	330	390	440
				Air Velocity v_a		CFM	318	360	466	593	699	826	932
				Air Flow Resistance Δp_a		Pa	1.0	1.1	1.5	1.9	2.2	2.6	2.9
2-05 2-08	1	I/h	kPa	Air Flow Resistance Δp_a		Pa	11	15	25	38	53	67	84
		108	0.02	Heat Output \dot{Q}		kW	1.15	1.20	1.28	1.33	1.38	1.43	1.45
		216	0.05				1.52	1.61	1.77	1.88	1.97	2.05	2.11
		540	0.26				1.98	2.13	2.43	2.65	2.83	2.99	3.12
		1152	0.98				2.26	2.46	2.86	3.31	3.45	3.70	3.89
	1980	2.54	2.40				2.64	3.11	3.46	3.64	4.10	4.34	
	2	I/h	kPa	Air Flow Resistance Δp_a		Pa	25	29	45	65	91	121	145
		216	0.07	Heat Output \dot{Q}		kW	2.52	2.69	3.03	3.27	3.47	3.64	3.77
		540	0.32				3.14	3.44	4.04	4.46	4.84	5.18	5.46
		1152	1.20				3.50	3.88	4.66	5.26	5.80	6.29	6.69
1980		3.11	3.67				4.11	4.98	5.69	6.33	6.91	7.41	
3060	5.03	3.72	4.18				5.08	5.81	6.49	7.11	7.64		

Sizes	Rows	Water Flow \dot{V}_w	Water Flow Resistance Δp_w	Air Flow \dot{V}		I/s	300	330	390	470	555	640	695	750
				Air Velocity v_a		CFM	636	699	826	996	1176	1356	1473	1589
				Air Flow Resistance Δp_a		Pa	1.2	1.3	1.5	1.9	2.2	2.5	2.7	3.0
4-06 4-12	1	I/h	kPa	Air Flow Resistance Δp_a		Pa	14	19	25	35	47	60	68	77
		108	0.02	Heat Output \dot{Q}		kW	2.03	2.11	2.18	2.25	2.32	2.38	2.39	2.42
		216	0.06				2.82	2.97	3.10	3.26	3.38	3.48	3.54	3.60
		540	0.29				3.83	4.13	4.40	4.72	4.97	5.20	5.33	5.46
		1152	1.08				4.52	4.95	5.32	5.79	6.19	6.58	6.78	6.99
	1980	2.80	4.88				5.38	5.85	6.43	6.93	7.40	7.65	7.91	
	2	I/h	kPa	Air Flow Resistance Δp_a		Pa	27	36	46	65	86	110	127	143
		216	0.09	Heat Output \dot{Q}		kW	4.94	5.31	5.64	5.99	6.29	6.50	6.66	6.79
		540	0.43				6.43	7.06	7.62	8.32	8.89	9.44	9.72	10.00
		1152	1.63				7.34	8.18	8.95	9.95	10.82	11.58	12.04	12.48
1980		4.19	7.80				8.76	9.65	10.82	11.86	12.79	13.37	13.91	
3060	6.79	7.94	8.94				9.86	11.08	12.17	13.16	13.78	14.36		

Hot Water Coil Performance Data

Size 5-7, 90 °C entering water

Sizes	Rows	Water Flow \dot{V}_w	Water Flow Resistance Δp_w	Air Flow \dot{V}		l/s	450	555	640	720	830	915	1100
						CFM	954	1176	1356	1526	1759	1939	2331
				Air Velocity v_a		m/s	3.0	3.7	4.3	4.8	5.6	6.1	7.4
5-08 5-14	1	l/h	kPa	Air Flow Resistance Δp_a	Pa	25	36	32	38	48	56	64	
		216	0.02	Heat Output \dot{Q}	kW	4.48	4.76	4.89	5.02	5.20	5.28	5.37	
		540	0.07			6.28	6.85	7.16	7.46	7.83	8.04	8.24	
		1152	0.33			7.53	8.36	8.85	9.33	9.89	10.26	10.60	
		1980	1.23			8.24	9.21	9.85	10.45	11.16	11.64	12.09	
	2520	3.18	8.63			9.69	10.40	11.07	11.86	12.41	12.91		
	2	l/h	kPa	Air Flow Resistance Δp_a	Pa	45	67	59	70	89	103	118	
		540	0.08	Heat Output \dot{Q}	kW	10.80	11.99	12.70	13.38	14.18	14.70	15.18	
		1152	0.40			12.59	14.26	15.32	16.31	17.45	18.27	19.03	
		1980	1.51			13.52	15.47	16.73	17.92	19.34	20.31	21.25	
2520		3.88	14.67			16.11	17.16	18.66	19.82	20.81	21.77		
3060	8.32	15.83	16.76			17.60	19.39	20.30	21.31	22.28			

Sizes	Rows	Water Flow \dot{V}_w	Water Flow Resistance Δp_w	Air Flow \dot{V}		l/s	600	695	835	970	1110	1250	1390	1500
						CFM	1271	1473	1769	2055	2352	2649	2945	3178
				Air Velocity v_a		m/s	1.2	1.4	1.6	1.9	2.2	2.5	2.7	3.0
6-10 6-16	1	l/h	kPa	Air Flow Resistance Δp_a	Pa	14	19	26	34	43	53	63	72	
		108	0.06	Heat Output \dot{Q}	kW	6.53	6.77	7.06	7.26	7.47	7.63	7.76	7.87	
		216	0.30			9.45	10.01	10.65	11.11	11.57	11.91	12.31	12.63	
		540	1.14			11.58	12.49	13.45	14.27	14.95	15.64	16.25	16.73	
		1152	2.95			12.81	13.96	15.17	16.26	17.11	17.99	18.76	19.38	
	1980	4.78	13.49			14.78	16.12	17.36	18.30	19.28	20.15	20.84		
	2	l/h	kPa	Air Flow Resistance Δp_a	Pa	27	35	48	63	80	98	117	133	
		216	0.46	Heat Output \dot{Q}	kW	16.63	17.91	19.28	20.45	21.36	22.22	23.02	23.67	
		540	1.75			19.86	21.78	23.72	25.57	27.05	28.54	29.75	30.71	
		1152	4.50			21.60	23.88	26.29	28.49	30.49	32.19	33.84	35.15	
1980		7.29	22.31			24.90	26.94	29.12	31.25	32.98	34.41	36.00		
3060	9.65	23.02	25.93			27.60	29.75	32.02	33.76	34.97	36.85			

Sizes	Rows	Water Flow \dot{V}_w	Water Flow Resistance Δp_w	Air Flow \dot{V}		l/s	900	1110	1250	1390	1530	1670	1805	1945	2100
						CFM	1907	2352	2649	2945	3242	3539	3825	4121	4450
				Air Velocity v_a		m/s	1.2	1.5	1.6	1.8	2.0	2.2	2.4	2.5	2.7
7-12 7-16	1	l/h	kPa	Air Flow Resistance Δp_a	Pa	13	20	24	29	34	39	45	51	58	
		108	0.35	Heat Output \dot{Q}	kW	16.19	17.28	17.80	18.40	18.74	19.15	19.58	20.00	20.42	
		216	1.32			20.59	22.34	23.37	24.28	24.98	25.84	26.45	27.05	27.66	
		540	3.39			23.32	25.57	26.88	28.04	29.07	30.14	30.93	31.72	32.51	
		1152	5.49			24.83	27.34	28.81	30.10	31.32	32.50	33.39	34.28	35.17	
	1980	8.13	26.33			29.12	30.74	32.17	33.57	34.86	35.85	36.84	37.84		
	2	l/h	kPa	Air Flow Resistance Δp_a	Pa	24	36	45	53	63	73	84	95	107	
		216	2.01	Heat Output \dot{Q}	kW	36.55	40.42	42.65	44.45	46.06	47.73	49.17	50.61	52.05	
		540	5.18			40.59	45.56	48.11	50.56	52.92	54.90	56.89	58.88	60.86	
		1152	8.39			42.27	46.70	49.27	51.41	54.25	55.47	57.69	59.86	61.96	
1980		12.35	43.94			47.84	50.44	52.26	55.59	56.03	58.49	60.84	63.05		
3060	17.08	45.61	48.98			51.61	53.11	56.92	56.59	59.29	61.82	64.14			

Electric Heater, Features and Selection

Electric Heater Performance Data

Standard Features

- Automatic Reset Thermal Cutout
 - Backup Thermal Cutout (Second Stage Protection)
 - Pneumatic Switches
 - Magnetic Relay
 - Transformer for 24 Volt Controls
 - Galvanized Steel Casing and Power Terminal Block
 - Nickel-chrome Heating Elements
 - Sealed Control Panel and Power Connections
- Voltage 220 VAC, 1-phase;
alternatively 380 VAC, 3-phase

Optional Features

- Mercury Disconnecting Relay
- Safety Fuse
- Man-reset Thermal Cutout
- Air Flow Switches
- Three-stage Power Control

Notes

1. Data is based on 20 °C Entering Air Temperature (EAT) at sea level.
2. For optimum diffuser performance in overhead heating applications, the supply air temperature should be within 11 K of the desired space temperature. This typically requires a higher air flow rate, which provides higher air motion in the space, increasing thermal comfort. The hot water coil should be selected with this in mind, keeping the Leaving Air Temperature (LAT) as low as possible.
3. With standard heater elements, the maximum capacity ($\dot{Q}_{E \max}$ in kW) is obtained by dividing the heating (fan) CFM by 70. In other words, the terminal must have at least 70 CFM per KW. In addition, each size terminal has a maximum allowable KW based upon the specific heater element configuration (i.e. voltage, phase, number of steps, etc.). Contact your TROX representative for design assistance.

Technical Data for Air-duct Supplementary Electric Heater

Size	Performance Data of Electric heating Coils											
2	Air Flow	l/s	140	180	220	265	305	335	360	390	415	445
		CFM	297	381	466	562	646	710	763	826	879	943
	Air flow resistance	Pa	3	4	5	14	17	20	23	27	37	48
	Power	kW	4.0	5.5	6.5	8.0	9.0	10.0	11.0	12.0	13.0	13.5
4	Air Flow	l/s	280	335	390	445	500	555	610	670	720	750
		CFM	593	710	826	943	1059	1176	1293	1420	1526	1589
	Air flow resistance	Pa	6	9	11	20	25	29	39	51	62	67
	Power	kW	8.5	10.0	12.0	13.5	15.0	17.0	18.5	20.5	22.0	13.0
5	Air Flow	l/s	445	500	585	670	750	835	915	970	1055	1110
		CFM	943	1059	1240	1420	1589	1769	1939	2055	2235	2352
	Air flow resistance	Pa	4	6	16	19	33	36	45	63	86	100
	Power	kW	13.5	15.0	18.0	20.0	23.0	25.5	28.0	29.5	32.0	34.0
6	Air Flow	l/s	585	670	750	860	970	1085	1170	1280	1390	1500
		CFM	1240	1420	1589	1822	2055	2299	2479	2712	2945	3178
	Air flow resistance	Pa	8	10	15	18	22	30	36	42	50	59
	Power	kW	18.0	20.5	23.0	26.0	29.5	33.0	35.5	39.0	42.0	45.5
7	Air Flow	l/s	890	1030	1170	1335	1470	1640	1805	1945	2085	2220
		CFM	1886	2182	2479	2829	3115	3475	3825	4121	4418	4704
	Air flow resistance	Pa	8	11	16	21	25	30	35	39	45	53
	Power	kW	27.0	31.5	35.5	40.5	45.0	50.0	55.0	59.0	63.5	67.0

Selection Process for TFP Units

Selection Process for TFP Units

A. Selection Data Required:

- Supply air volume (max. primary air volume $\dot{V}_{pri\ max}$ and max. fan supply air volume $\dot{V}_{fan\ max}$) l/s
- External duct static pressure loss Δp_{ex} (not including heating coil)
- Inlet static pressure Δp_{in}
- Heating requirements (power of hot water heating coil or electric heating coil, if heating coil is required)
- Maximum allowable NC or Sound Power
- Details about box installation (e.g. outside dimension etc.)

B. Selecting Suitable Dimension according to the Supply Air Volume

Select a TFP unit size from technical data table (page 12) that most closely matches the design supply air volume $\dot{V}_{fan\ max}$.

For optimum controllability, select smaller size if required volume flow can be reached. Oversizing will degrade the effective operating range of the unit.

C. According to the required external duct static pressure loss

Δp_{ex} , design volume flow \dot{V}_{fan} can be selected using the fan function curves on page 13.

D. Heating Coil Selection

Electric heating coil is required

Confirm that the design heating power kW does not exceed the maximum allowable power kW using selection table for electric heating coil

Hot water heating coil is required

According to the design power (kW), supply air volume and temperature of supply and return water, heating coil can be selected based on the selection procedure for heating water coil (Page 45-48).

Then check the fan curve.

E. Checking the Acoustic Data

Find the max. discharge and radiated noise NC value using Quick-Select Table (page 14 ...18) according to the selected size. Confirm that the unit size selected does not exceed the maximum allowable NC. If the unit selected exceeds the maximum allowable NC or Sound Power, then select the next larger unit size and repeat steps (C and D).

Example (Typical Installation)

A. Given design requirements:

- primary air volume $\dot{V}_{pri} = 350$ l/s (742 CFM)
- supply air volume $\dot{V}_{fan} = 528$ l/s (1120 CFM)
- External duct (downstream) static pressure loss $\Delta p_{ex} = 75$ Pa
- Inlet static pressure $\Delta p_{in} = 250$ Pa
- Electric heating coil = 6 kW
- Maximum allowable NC = 35
- Installation not acoustically critical

B. Selection of TFP according to the supply air volume

Select TFP-E-/4-10 using selection table (Page 12) of catalogue for TFP-FAN-BOX.

C. Using the fan curve on page 25, Medium Tap, 215 VAC

Confirm that the fan supply air volume takes 528 l/s based on the external duct static pressure $\Delta p_{ex} = 75$ Pa.

D. Maximum allowable electric heating coil power

$\dot{Q}_{E\ max} = 16$ kW (limit value see notes on Page 49)

$\dot{Q}_E = 6$ kW < $\dot{Q}_{E\ max}$

Therefore, 6 kW at an supply air volume of 528 l/s (1120 CFM) is acceptable.

E. Checking the acoustic data

Using Quick-Select Table, confirm according to the supply air volume and Δp_{in} that supply airflow NC is 15 and radiated NC is 21, not exceeding the maximum allowable NC35.

Selection Result:

The design requirements can be met with the selection of type TFP-E/4-10/.

Specification Text

Series Fa VAV Boxes type TFP for constant room air supply volume combined with VAV primary air control having high turndown by use of a multi-point flowgrid. Induction of warm air from the ceiling void by forward blade centrifugal fan with direct drive motor.

Single blade control damper with seal for shut off. Required flow rate to enable fan duty to be set to match the tap transformer.

Materials

Casing manufactured from galvanized sheet steel. Internally lined with faced insulation.

Multi-point flowgrid constructed from aluminium tubes. Fan casing manufactured from sheet steel. Fan impeller from aluminium alloy or steel according to size.

Order Code – Fan Assisted Terminal Box

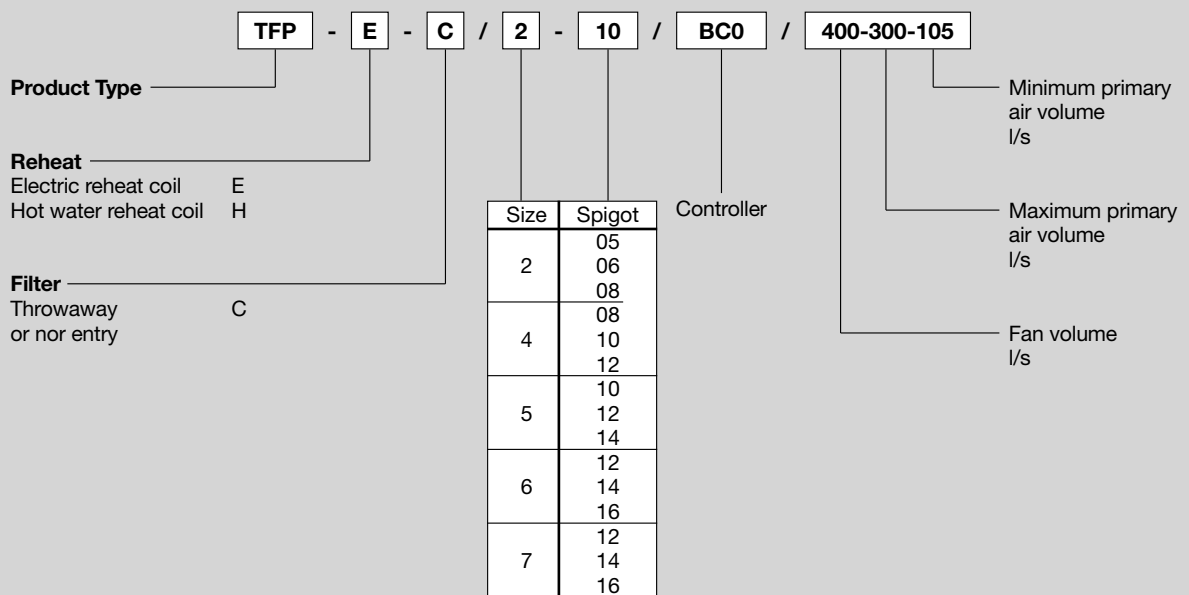

Order Example

Make: TROX
 Type: TFP - E - C / 2 - 10 / BC0 / 400-300-105

